

**500 Series
Industrial
Ethernet
Switches**

**Installation
Guide**

Table of Contents

Applicability.....	3
Safety Warnings.....	4
ATEX Installation Requirements.....	6
Overview: 500 Series Industrial Ethernet Switches.....	7
Key Features.....	8
Installation.....	8
Panel and Rack Mounting.....	9
Front Panel.....	10
Applying Power (Side View).....	11
N-Tron Switch Grounding Techniques.....	12
RJ45 Connector Crimp Specifications.....	13
Connecting the Unit.....	14
Serial Interface.....	14
Troubleshooting.....	15
FCC Statement.....	15
Command Line Interpreter.....	16
Logging In (password protection).....	17
CLI Tree of Menus.....	18
CLI Menus and Commands.....	20
Home Menu.....	20
Top Level Info.....	20
System Menu.....	21
N-View™ Menu.....	21
Aging Menu.....	22
System Info.....	23
Restoring defaults.....	23
User Password.....	24
Switch Menu.....	25
Port Mirroring.....	25
MAC Based Trunking.....	27
QOS.....	29
VLAN.....	31
Tagged VLAN.....	32
Port VLAN.....	38
IGMP Snooping.....	42
Filters.....	46
Ports.....	49
500 Series Stacked Switches IGMP Multicast Limitations.....	52
Key Specifications (508TX).....	54
Key Specifications (508FX2/FXE2).....	56
Key Specifications (509FX/FXE).....	58
Key Specifications (516TX).....	60
Key Specifications (517FX/FXE).....	62
Key Specifications (524TX).....	64
Key Specifications (526FX2/FXE2).....	66

Applicability:

This guide is applicable to Firmware Version 8 of the following products:

508TX-N
516TX-N
524TX-N

508FX2-N-XX-S
509FX-N-XX-S
517FX-N-XX-S
526FX2-N-XX-S

508FXE2-N-XX-YY
509FXE-N-XX-YY
517FXE-N-XX-YY
526FXE2-N-XX-YY

Where: N = N for N-View™
= A for Advanced Management
= Blank Otherwise

XX = ST or SC and YY = -15, -40, -80

S = Standard Temperature Rating -20° C to 70° C
= Blank for -40° C to 85° C

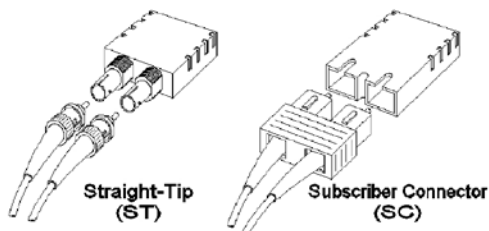

Note: The firmware version can be seen on the power up banner on the serial console for any of these products.



Copyright, © N-TRON Corp., 2008
820 S. University Blvd., Suite 4E
Mobile, AL USA 36609

All rights reserved. Reproduction, adaptation, or translation without prior written permission from N-TRON Corp. is prohibited, except as allowed under copyright laws.

Ethernet is a registered trademark of Xerox Corporation. All other product names, company names, logos or other designations mentioned herein are trademarks of their respective owners.

The information contained in this document is subject to change without notice. N-TRON Corp. makes no warranty of any kind with regard to this material, including, but not limited to, the implied warranties of merchantability or fitness for a particular purpose. In no event shall N-TRON Corp. be liable for any incidental, special, indirect or consequential damages whatsoever included but not limited to lost profits arising out of errors or omissions in this manual or the information contained herein.

Warning:

Do not perform any services on the unit unless qualified to do so. Do not substitute unauthorized parts or make unauthorized modifications to the unit.

Do not operate the unit with the top cover removed, as this could create a shock or fire hazard.

Do not block the air vents on the sides or the top of the unit.

Do not operate the equipment in the presence of flammable gasses or fumes. Operating electrical equipment in such an environment constitutes a definite safety hazard.

Do not operate the equipment in a manner not specified by this manual.

Safety Warnings

GENERAL SAFETY

WARNING: If the equipment is used in the manner not specified by N-TRON Corp., the protection provided by the equipment may be impaired.

Contact Information

N-TRON Corp.
820 South University Blvd.
Suite 4E
Mobile, AL 36609
TEL: (251) 342-2164
FAX: (251) 342-6353
Website: www.n-tron.com
Email: N-TRON_Support@n-tron.com

ENVIRONMENTAL SAFETY



WARNING: Disconnect the power and allow to cool 5 minutes before touching.

ELECTRICAL SAFETY



WARNING: Disconnect the power cable before removing the enclosure top.

WARNING: Do not operate the unit with the top cover removed.

WARNING: Do not work on equipment or cables during periods of lightning activity.

WARNING: Do not perform any services on the unit unless qualified to do so.

WARNING: Do not block the air vents.

WARNING: Observe proper DC Voltage polarity when installing power input cables. Reversing voltage polarity can cause permanent damage to the unit and void the warranty.

LASER SAFETY (FXE-40,-80 Only)



CAUTION: CLASS 1 LASER PRODUCT. Do not stare into the laser!

UL/cUL Hazardous Location Installation Requirements

1. **WARNING:** Do not disconnect while circuit is live, unless area is known to be non-hazardous.
2. **WARNING:** Install only in accordance with Local & National Codes of Authorities Having Jurisdiction.
3. **Power must be supplied by an isolating source, and a 3.3A max rated UL recognized fuse must be installed immediately before the unit.**
4. Class I, Div 2 installations require that all devices connected to this product must be UL listed for the area in which it is installed.
5. Only UL listed wiring with temperature ratings greater than 90°C permitted for Class I, Div 2 installations operating at temperatures up to 70°C ambient.
6. Limited Operating Voltage: 12-30V for Class I, Div 2 installations.

ATEX Installation Requirements

1. The conductor size of the phase conductor must be in the range of 0.05-2.08 mm².
2. Field wiring must be suitable for a minimum of 110°C.
3. Ethernet Switches are intended for mounting in an IP54 enclosure in a pollution degree 2 environment.
4. Temperature testing of the Ethernet Switches was conducted on the switch itself in an 85°C air-circulating oven and resulted in a Temperature Code of T4. However, end-product temperature testing shall be considered.
5. The end user shall provide bonding means as necessary. All bonding equipment (components) shall be evaluated according to EN 60079-15:2005 and covered by a component certificate for the actual use. When installing bonding components that will pass through an enclosure wall, they must have a minimum of IP54 rating equal to the enclosure. All electrical clearances must be maintained per the manufacturer's instructions of the bonding component or per EN 60079-15:2005.
6. Ethernet Switch requires protection against transients. The end-product shall provide a suitable form of protection that removes the risk of or limits transients to no more than 42V.

Overview: 500 Series Industrial Ethernet Switches

The 500 Series Industrial Ethernet Switches support high speed layer 2 switching between ports.

The 508TX (516TX)(524TX) is an affordable 8 (16)(24) port switch that is capable of auto negotiating 10/100 Mb and half/full duplex communications. The N-TRON 508TX (516TX)(524TX) is housed in a ruggedized steel enclosure, and provides 8 (16)(24) Category 5 compliant 10/100-BaseTX connections for high performance network design, and hub/repeater upgrades.

The 509FX (517FX)(526FX) is a 9 (17)(26) port switch that has 8 (16)(24) ports identical to the 508TX (516TX)(524TX), plus an additional multimode fiber optic up-link port in the 509FX and 517FX, and two additional multimode fiber optic up-link ports in the 526FX. These fiber links are capable of 2 Kilometers of 100 Mb communications without the use of repeaters.

The 509FXE (517FXE) (526FXE) is a 9 (17)(26) port switch that is similar to the 509FX (517FX) (526FX), but with extended range. The FXE versions utilize a singlemode fiber transceiver that is capable of 15-80 Kilometers of 200 Mb communications.

The 508FX2 is an 8 port switch that has 6 copper ports plus two additional multimode fiber optic up-link ports. The 508FXE2 is similar to the 508FX2 , but is populated with singlemode extended range fiber optics.

All FX, FX2, FXE, and FXE2 models utilize the IEEE compliant SC or ST duplex connector for fiber optic communications. The 10/100Base-TX ports utilize the RJ45 shielded connector.

All N-TRON switches come housed in a steel ruggedized Din-Rail enclosure, designed to withstand the most demanding industrial applications, and have been fully tested and certified at industrial environmental extremes. All 500 Series Units operate on 10-30VDC.

Key Features

- Full IEEE 802.3 & 100BASE-FX Compliance
- Full IEEE 1613 Compliance (Communications Networking Devices in Electric Power Stations)
- NEMA TS1/TS2 Compliance (Traffic Control Systems)
- American Bureau of Shipping (ABS) Type Approval (Maritime and Offshore Applications)
- Extended Environmental Specifications
- Support for Full/Half Duplex Operation
- LED Link/Activity Status Indication
- Auto-Sensing Speed and Flow Control
- Up to 2.6 Gb/s Maximum Throughput
- Industry Standard 35mm DIN-Rail Enclosure
- Optional **N-View™** Monitoring
- Optional Advanced Management Features
 - Port Mirroring
 - Mac Based Trunking
 - Quality of Service - traffic priority (port or tagged)
 - VLAN (port or tagged)
 - IGMP Snooping (Plug and Play out of box)



PACKAGE CONTENTS

Please make sure the Ethernet Switch package contains the following items:

1. 500 Series Switch
2. Product CD

Contact your carrier if any items are damaged.

Installation

Read the following warning before beginning the installation:

WARNING



The 500 Series FXE-40 and FXE-80 units contain a class 1 laser. Do not stare into the laser beam (fiber optic connector) when installing or operating the product.

WARNING



Never install or work on electrical equipment or cabling during periods of lightning activity. Never connect or disconnect power when hazardous gasses are present.

Disconnect the power cable before removing the enclosure top.
Do not operate the unit with the top cover removed

UNPACKING

Remove all the equipment from the packaging, and store the packaging in a safe place. File any damage claims with the carrier.

CLEANING

Clean only with a damp cloth.

SERVICING

No user serviceable parts inside. Removing the top cover will void the warranty.

DIN-Rail Mounting

Install the unit on a standard 35mm Din-Rail. Recess the unit to allow at least 5" of horizontal clearance for fiber optic cable bend radius (2" for TX models).

Panel and Rack Mounting

With the exception of the 524TX and 526FX2, all N-Tron™ products are designed to be mounted on industry standard 35mm DIN-Rail. However, DIN-Rail mounting may not be suitable for all applications. We offer two alternative mounting solutions: Our 900 Panel Mount Assembly (P/N: 900-PM) may be used to securely mount our 100, 200, 300, 400, **500**, or 900 Series products to a panel or other flat surface; Our Universal Rack Mount Kit (P/N: URMK) may be used to mount our products to standard 19" racks

900-PM

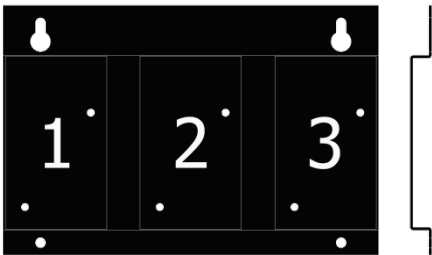

URMK

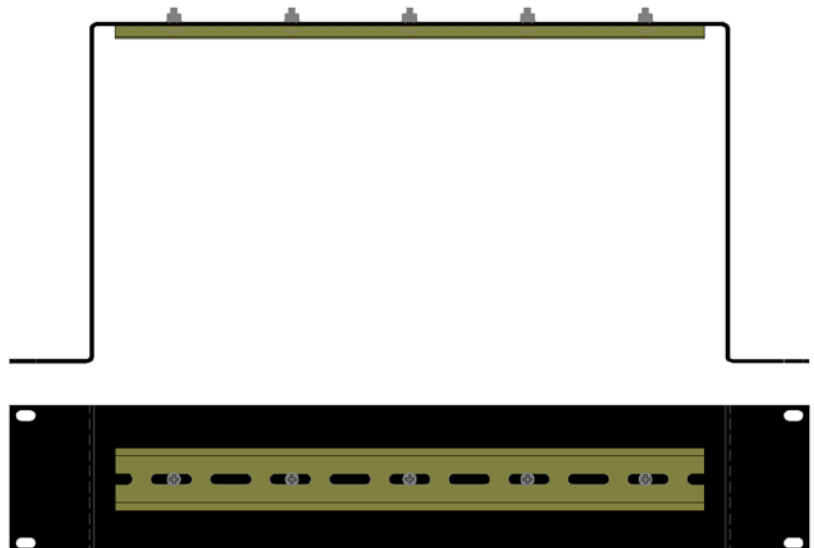

Front Panel



From Left to Right:

- LNK** Link LED for Fiber Optic Port (only FX/FXE models)
- TX** 100MB/s Fiber Optic TX Port (only FX/FXE models)
- RX** 100MB/s Fiber Optic RX Port (only FX/FXE models)
- ACT** Activity LED for Fiber Optic Port (only FX/FXE models)
- RJ45 Ports** Auto sensing 10/100 BaseTX Connections
-  Green LED lights when Power is connected

NOTE: Each RJ45 data port has two LED's located at the top or bottom of each connector. The left LED indicates LINK status (green for 100Mb link, Orange for 10Mb link), and the right LED indicates ACTIVITY (Green for Full Duplex activity, Orange for Half Duplex Activity).

LED's: The table below describes the operating modes:

LED	Color	Description
	GREEN	Power is Applied
	OFF	Power is OFF

LNK	GREEN	100Mb Link between ports
	ORANGE	10 Mb Link between ports
	OFF	No Link between ports
ACT	GREEN	Data is active between ports and operating in full duplex
	ORANGE	Data is active between ports and operating in half duplex
	OFF	Data is inactive between ports

Applying Power (Side View)

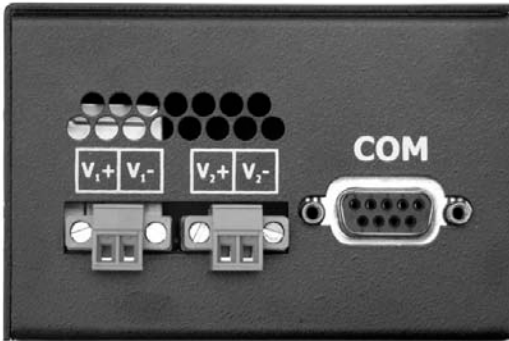

Unscrew & Remove the DC Voltage Input Plug(s) from the side header
Install the DC Power Cables into the Plug(s) (observing polarity).
Plug the Voltage Input Plug(s) back into the side header.
Tightening torque for the terminal block power plug is **0.22 Nm/0.162 Pound Foot**.
All LED's will flash ON Momentarily
Verify the Power LED stays ON (GREEN).

Note: Only 1 plug must be connected to power for minimal operation. For redundant power operation, V₁ and V₂ plugs must be connected to separate DC Voltage sources. Use wire sizes 16-28 gauge. The power cord should be limited to less than 10 meters in order to ensure optimum performance.

Recommended 24V DC Power Supplies, similar to
100VAC/240VAC:

N-Tron's NTPS-24-1.3, DC 24V/1.3A. (NOTE: Not appropriate for use with M12, POE, and HV models.)

Note: For 526FX2 please use the NTPS-24-3, DC 24V/3.0A

N-Tron Switch Grounding Techniques

The grounding philosophy of any control system is an integral part of the design. N-Tron switches are designed to be grounded, but the user has been given the flexibility to float the switch when required. The best noise immunity and emissions (i.e. CE) are obtained when the N-Tron switch chassis is connected to earth ground via a drain wire. Some N-Tron switches have metal din-rail brackets that can ground the switch if the din-rail is grounded. In some cases, N-Tron switches with metal brackets can be supplied with optional plastic brackets if isolation is required.

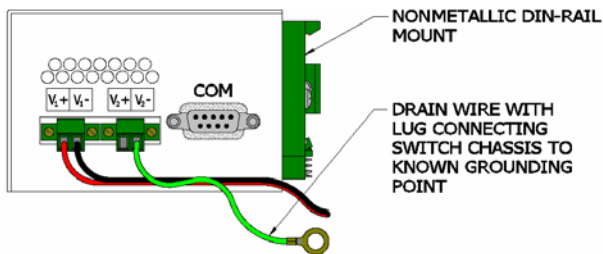

Both V- legs of the power input connector are connected to chassis internally on the PCB. Connecting a drain wire to earth ground from one of the V- terminal plugs as shown here will ground the switch and the chassis. The power leads from the power source should be limited to 3 meters or less in length.

As an alternate, users can run a drain wire & lug from any of the Din-Rail screws or empty PEM nuts on the enclosure. When using an unused PEM nut to connect a ground lug via a machine screw, care should be taken to limit the penetration of the outer skin by less than 1/4 in. Failure to do so may cause irreversible damage to the internal components of the switch. **Please note that the minimum cross-sectional area of the grounding conductor must be at least 4mm² and it must be suitable for use in temperature of 110°C.**

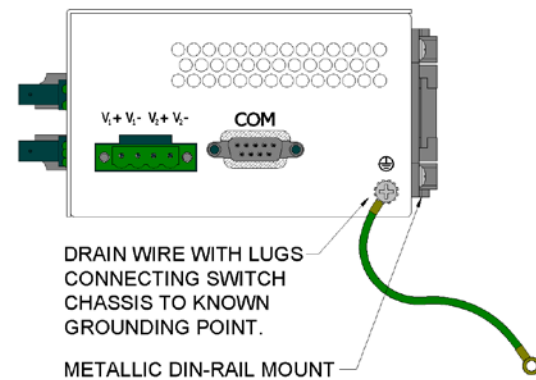

Note: Ensure the power supply is grounded properly before applying power to the grounded switch. This may be verified by using a voltmeter to determine that there is no voltage difference between the power supply's negative output terminal and the chassis grounding point of the switch.

If the use of shielded cables is required, it is generally recommended to only connect the shield at one end to prevent ground loops and interfere with low level signals (i.e. thermocouples, RTD, etc.). Cat5e cables manufactured to EIA-568A or 568B specifications are required for use with N-Tron Switches.



In the event all Cat5e patch cable distances are small (i.e. All Ethernet devices are located the same local cabinet and/or referenced to the same earth ground), it is permissible to use fully shielded cables terminated to chassis ground at both ends in systems void of low level analog signals.

RJ45 Connector Crimp Specifications

Please reference the illustration below for your Cat5 cable specifications:

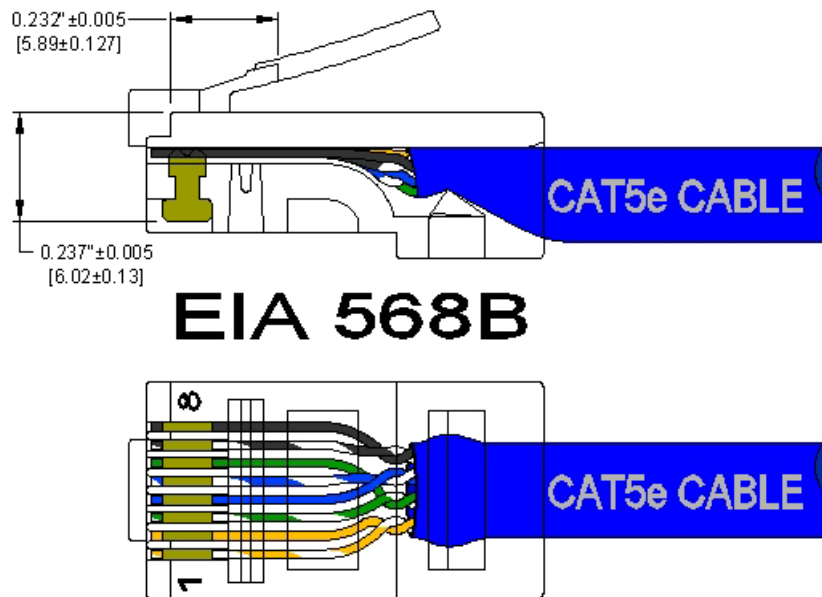

Connecting the Unit

For FX/FXE units, remove the dust cap from the fiber optic connectors and connect the fiber optic cables. The TX port on the FX/FXE models should be connected to the RX port of the far end station. The RX port on the FX/FXE versions should be connected to the TX port of the far end station.

For 10/100 Base-TX ports, plug a Category 5E twisted pair cable into the RJ45 connector. Connect the other end to the far end station. Verify that the LNK LED's are ON once the connection has been completed. To connect any other port to another Switch or Repeater, use a standard Category 5 straight through or crossover cable.

Warning: Creating a port to port connection on the same switch (i.e. loop) is an illegal operation and will create a broadcast storm which will crash the network!

Note: For units which have the **N-View Option**, you can validate that all ports are working correctly by installing the N-View OPC Server software. The software is freely distributed on the ProductCD and our website (<http://www.n-tron.com/html/opc.html>). Once the software is installed, you should view the Ports Counter page to remotely monitor each connected port. You may find it helpful to copy [Alt]+[Print Screen] the Port Counter information for each port and paste [Control]+[V] into a Windows document for further review. Please consult your N-View OPC Server Manual for additional information.

Serial Interface

The 500 series switches provide an EIA-232 interface accessed via a 9 pin female connector (labeled 'COM' on the unit). This is used to access the Command Line Interpreter (CLI). The pin-outs are shown below:

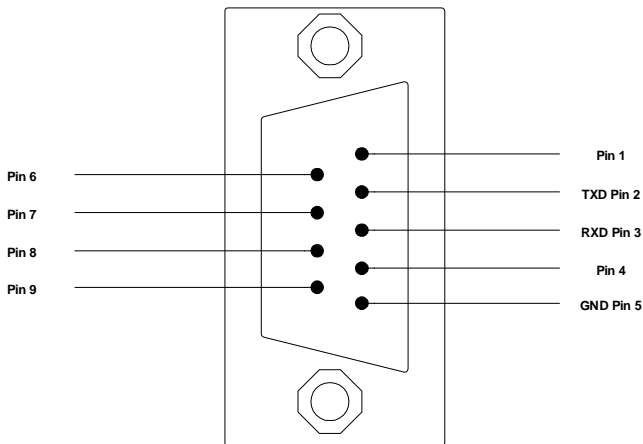

Serial Cable

Connect the serial COM port of your PC and the 500 Series Switch using a standard straight through cable. You will require a cable with a 9-pin or 25-pin sub-D female connector for the PC end, and a 9-pin male sub-D connector for the series 500 end.

The following table shows the pin-out and the connections for both types of cable:

PC Port	25-Pin Female	9-Pin Female	500 series 9-Pin Male	
Signal Name	Pin #	Pin #	Pin #	Signal Name
TXD	2	3	3	RXD
RXD	3	2	2	TXD
GND	7	5	5	GND

Shielded cables and null modems are readily available from Radio Shack or a variety of computer shops.

HyperTerminal

The following configuration should be used in HyperTerminal:

Port Settings: 9600
Data Bits: 8
Parity: None
Stop bits: 1
Flow Control: None

Troubleshooting

1. Make sure the  (Power LED) is ON.
2. Make sure you are supplying sufficient current for the version chosen.
3. Verify that Link LED's are ON for connected ports.
4. Verify cabling used between stations.
5. Verify that cabling is Category 5E or greater for 100Mbit Operation.
6. For FX/FXE models, verify TX is connected to far end RX and vice versa. Also insure the connecting partner is 100Mb/s IEEE 100BaseFX compliant. Note: the 500 Series FX/FXE switches do not support the 10BaseFL standard.

SUPPORT

Contact N-TRON Corp. at:
TEL: 251-342-2164
FAX: 251-342-6353
www.n-tron.com
N-TRON_Support@n-tron.com

FCC Statement

This product complies with Part 15 of the FCC-A Rules.

Operation is subject to the following conditions:

- (1) This device may not cause harmful Interference
- (2) This device must accept any interference received, including interference that may cause undesired operation.

Software Configuration

Command Line Interpreter

With the '-A' option, you can configure and/or query all the important parameters of an N-Tron 500 series industrial Ethernet switch using a command line interpreter. These functions may be accessed using the serial port (marked COM).

To access the Command Line Interpreter (CLI), connect a PC serial port to the 500 Series V24 serial port and use HyperTerminal or equivalent.

COM Parameters: 9600, 8, none, 1, none

After a successful connection and reboot, the boot menu should be displayed:

```
Self Test & System Initialization Complete..... OK!

N-TRON Industrial Ethernet Switch - Model Number: 526 FX-A.
N-Tron firmware version : 8.01
Copyright (c) 2005 N-TRON

MAC ADDRESS:00-07-AF-00-05-26

N-View is ENABLED.
Trunking (Link Aggregation) is DISABLED.
Mirroring is DISABLED.
Tagged QOS is DISABLED.
Port QOS is DISABLED.
VLAN is DISABLED.
IGMP Snooping is ENABLED.
Aging is ENABLED.

Managing IGMP Snooping.....

Exit to return to Management Console Function.

Press [ESC] to Exit >
```

**Note that example above is for a –A unit, and so has the login capability.
Only aging, N-View and IGMP Snooping are enabled by default on a –A unit.
Only aging and N-View are enabled on a –N unit.
Only aging is enabled on a basic (no dash) unit.**

This information includes the model number, firmware version, and MAC address.

Also, information is presented as to which functions are enabled, for example in this case above:

- **N-View™**, Aging and IGMP Snooping are reported as enabled (default).
- Trunking, mirroring, Port QOS, Tagged QOS, and VLAN are reported as disabled (default).

Note: Prior to version 7.08 firmware, Tagged QOS was enabled by default on –A units.

Logging In (password protection)

Access using the CLI is password-protected. You can log in as administrator to read and modify the 500 Series switch parameters. Note: The factory defaults **admin** password is **admin**.

First press <Escape> to access the Management Console Function.

Login: enter username '**admin**' and then press <Enter>.

Password: enter password '**admin**', then press <Enter>.
(see section on user defined password)

Example:

```
Managing IGMP Snooping.....
Exit to return to Management Console Function.
Press [ESC] to Exit >
** Now in user interface mode. **
** IGMP Snooping will resume after power is cycled. **

Login - (Enter Username)> admin
Username is correct.

Login continued - (Enter Password)> *****
Password is correct.

CUSTOMER USER VALIDATED.

/          (Go to top of menu tree)
?          (Show menus/commands)

info       (Show identification data)
SYSTEM    (Open system menu)
SWITCH    (Open switch menu)

CLI>
```

You can now activate the commands of the CLI.

CLI Tree of Menus

- **info** (Show identification data)

- **SYSTEM** (Open system menu)
 - **nview** (Get information about N-View function)
 - info (Get information about N-View)
 - enable/disable (Enable/Disable N-View)
 - **aging** (Aging Time for dynamically learned addresses)
 - info (Get information about Aging)
 - enable/disable (Enable/Disable Aging)
 - config (Configure Aging)
 - **info1** (Get information about system - ports 1->8)
 - **info2** (Get information about system - ports 9->16)
 - **info3** (Get information about system - ports 17->24)
 - **info4** (Get information about system - ports 25 & 26)
 - **upwd** (Set a user defined password)
 - **restore** (Restore factory defaults) ****Note: Power cycle is required when completed.**

- **SWITCH** (Open switch menu)
 - **mirror** (mirroring)
 - info (Get information about Mirroring)
 - enable/disable (Enable/Disable Mirroring)
 - config (Configure Mirroring)
 - **trunking** (Assign Port Trunking Groups)
 - info (Get information about Trunking)
 - enable/disable (Enable/Disable Trunking)
 - config (Configure Trunking)
 - **qos** (Quality of Service - traffic priority)
 - info (Get information about QOS)
 - en_tag/dis_tag (Enable/Disable Tagged QOS - 802.1p)
 - set_tag (Set Tagged QOS threshold - 802.1p)
 - en_port/dis_port (Enable/Disable Port QOS)
 - set_port (Set Port QOS - higher priority ports)
 - **vlan** (Virtual Local Area Networks)
 - info (Get information about VLAN)
 - enable/disable (Enable/Disable VLAN)
 - if tagged now:
 - untagged (Untagged pkt handling)
 - port (Switch to Port Based VLAN)
 - if port now:
 - tagged (Switch to Tagged VLAN)
 - group1 (configure tagged VLAN Group 1)
 - group2 (configure tagged VLAN Group 2)
 - group3 (configure tagged VLAN Group 3)
 - group4 (configure tagged VLAN Group 4)
 - group5 (configure tagged VLAN Group 5)
 - group6 (configure tagged VLAN Group 6)
 - group7 (configure tagged VLAN Group 7)
 - group8 (configure tagged VLAN Group 8)
 - cleargroups (clear all 8 tagged VLAN Groups)

(continued)

(SWITCH Sub-Menu Continued)

- **igmp (IGMP Snooping)**
 - info (Get information about IGMP Snooping)
 - enable/disable (Enable/Disable IGMP Snooping)
 - routers (Manage Router Port(s) for IGMP Snooping)
 - 'A' to Auto-detect plus manual, OR
 - 'M' for Manual only, OR
 - 'N' for None.
 - rfilters (Manage Router Multicast Data Filters)
 - query (Manage Query Generation)
 - 'A' to Auto query, OR
 - 'O' for query On, OR
 - 'F' for query oFF.
- **filters (Select traffic filter(s))**
 - info (Get info on Filters)
 - bfilter (Configure Broadcast Filter Ports)
 - sfilter (Configure Static Multicast Filter)
- **ports (Reconfigure Individual Port Parameters)**
 - info (Get info on Port Parameters)
 - enabling (Enable or disable each port)
 - negotiate (Select autonegotiate or not for each port)
 - speed10 (Force 10 Mb speed for each port)
 - speed100 (Force 100 Mb speed for each port)
 - half (Force half duplex for each port)
 - full (Force full duplex for each port)
 - crossover (Force crossover connection for each port)
 - link10h (Advertise 10Mb and half for each port)
 - filter (Configure Collision Filter for each port)
 - squelchon (Squelch more than IEEE standard.)
(or 'squelchoff' if currently on)

CLI Menus and Commands

These commands are available at all menus (on a –A unit):

Command	Description	Comment
/	Returns you to the top of menu tree (available in every menu)	Home function
?	Displays the current menu again (available in every menu)	Refresh function

Also: “u” or “U” = up one level in the menu tree
\
= home

Home Menu

You can display all the other menus from the start menu. This is displayed immediately after you login and includes the following commands:

Command	Description	Comment
info	Displays information about the switch	Model Number, firmware version, MAC address, which functions are presently enabled.
SYSTEM	Opens the SYSTEM menu.	The SYSTEM menu is used to set the system parameters.
SWITCH	Opens the SWITCH menu.	You can make settings for the switch in this menu.

Top Level Info

Top level info includes Model Number, Firmware version, MAC Address, and whether or not each major function is enabled.

Example of the (top level) info screen:

```
CLI>info
Self Test & System Initialization Complete..... OK!

N-TRON Industrial Ethernet Switch - Model Number: 524 TX-A.
N-Tron firmware version : 8.01
Copyright (c) 2005 N-TRON

MAC ADDRESS:00-07-AF-00-05-24

N-View is ENABLED.
Trunking (Link Aggregation) is DISABLED.
Mirroring is DISABLED.
Tagged QOS is DISABLED.
Port QOS is DISABLED.
VLAN is DISABLED.
IGMP Snooping is ENABLED.
Aging is ENABLED.

CLI>
```

System Menu

Command	Description	Comment
nview	Get information about N-View™ function.	
aging	Set and get info on Aging Time for dynamically learned addresses	
info or info1, info2,...	Displays the current system status. (info for 508/9)(info1,2 for 516/7) (info1,2,3,4 for 524) (info1,2,3,4 for 526)	LINK Status. Rate, Flow, etc.
upwd	Set a user defined password.	
restore	Restores the defaults of the switch (complete reset). **Note: Power cycle is required when completed.	restores the factory settings of the switch. With the exception of the “protected settings” (see ‘Restoring Defaults’), the settings made by the user are reset to the default values.

N-View™ Menu

With the N-View™ OPC software and an appropriate OPC viewer, one can monitor port and switch status via the LAN. When enabled, periodic Multicast MAC packets are sent out from every port.

Note: The configuration console is only available with –A models.

Command	Description	Comment
info	Displays the current values of the switch settings	MAC address, Enabled or disabled
disable (or enable)	Enable or Disable N-View™	Choice is opposite of current state

Notes on N-View™:

- With ‘-A’ option, either all ports are ‘on’, or all ports are ‘off’.
- With the ‘-N’ option all ports are ‘on’.
- Rate for generation of MIB information frames is ~6.4 seconds.
- The N-View™ frames are not mirrored.
- The FX Port is mapped to port 9 on the 509, and as port 17 on the 517. On the 508FX2, ports 7 and 8 are FX ports. On the 526FX, Ports 25 and 26 are FX ports.

Example of the N-View info screen:

```

CLI\SYSTEM\N-VIEW>info

N-View is ENABLED.

MAC ADDRESS:00-07-AF-00-05-26

/                (Go to top of menu tree)
?                (Show menus/commands)

info             (Get information about N-View)
disable          (Disable N-View)

CLI\SYSTEM\N-VIEW>

```

Aging Menu

When enabled, the Aging Time for dynamically learned addresses can be set from 10 to 300 seconds. The default is 300 seconds, except it is 20 seconds for 508FX2 and 526FX2. Cycling power clears the learned addresses.

Note: The configuration console is only available with –A models.

On –N and basic (no dash) units, aging is enabled and uses the defaults above without the option for reconfiguration.

Command	Description	Comment
info	Displays the current Aging settings.	Default is 300 seconds, except it is 20 seconds for 508FX2 and 526FX.
disable (or enable)	Enable or Disable Aging	Choice is opposite of current state
config	Choose aging time.	10 to 300 seconds

Example of the Aging config screen:

```
CLI\SYSTEM\AGING>config  
  
Configure Aging Time.  
  
The aging process is Enabled.  
  
Aging time is now 20 seconds.  
  
Enter an aging timeout ( 10 to 300 seconds),  
or <ESC> to exit> 15  
  
The aging process is Enabled.  
  
Aging time is now 15 seconds.  
  
CLI\SYSTEM\AGING>
```

Example of the Aging info screen:

```
CLI\SYSTEM\AGING>info  
  
The aging process is Enabled.  
  
Aging time is now 15 seconds.  
  
CLI\SYSTEM\AGING>
```

System Info

System info provides information on each port, as shown in the example below. Note that this is real time status, and some parameters (such as Rate, Duplex, and Crossover) will oscillate if not linked and not forced. To see forced settings, go to switch/ports/info.

Example of a system 'info' screen:

```
CLI\SYSTEM>info3
```

SYSTEM INFORMATION								
PORT	17	18	19	20	21	22	23	24
LINK	DOWN	DOWN	DOWN	DOWN	DOWN	UP	DOWN	DOWN
Enabled	ON	OFF	ON	ON	ON	ON	ON	ON
Negotiate	ON	ON	OFF	ON	ON	ON	ON	ON
Rate	---	---	10	---	---	100	---	---
Duplex	---	---	HALF	---	---	FULL	---	---
Crossover	NO	NO	NO	YES	NO	YES	YES	NO
NView	ON	ON	ON	ON	ON	ON	ON	ON
Mirror	IN	CAP	OFF	OFF	OFF	OFF	OFF	OFF

```
CLI\SYSTEM>
```

Restoring defaults

Restoring factory defaults has these affects (on a –A unit):

- **N-View™** is enabled.
- IGMP Snooping is enabled.
 - Query mode is auto and Query Frame Source IP is based on the switch's MAC Address.
 - Router ports mode is auto detect and there are no Manually Selected Router Ports.
 - The Multicast addresses and group members are cleared.
 - After firmware version 8.09, the Router Multicast Data Filter is enabled on all ports.
- Filtering:
 - Broadcast Filter is disabled. (All ports receive broadcast messages.)
 - Static Multicast Filter is cleared.
- Tagged QOS is disabled and the threshold is set to 4. Port QOS is disabled and no ports are chosen.
- Mirroring is disabled.
 - The default source port is set to 1.
 - The default capture (destination) port is set to 2. (when enabled)
 - Both TX and RX are set to be mirrored (when enabled).
- VLAN is disabled, tagged vlan is selected, and all VLAN groups are cleared (no VIDs and no members), except group1 has a VID of 1 and all ports as members (when enabled). Incoming untagged pkts to all ports are discarded.
- Trunking is disabled.
 - Group1 active and Group2 inactive (when enabled).
- Aging is enabled and the default is 300 seconds, except it is 20 seconds for the 508FX2 and 526FX.
- All RJ45 ports are set for auto-sensing. All FX ports are set to 100 MHz and Full Duplex.

The MAC address, model number, and firmware version are protected settings. These settings are unaffected by restoring factory defaults.

User Password

The user password feature is optional and if used allows the user to create a password of 4 to 8 characters, including alphanumerics and special characters (20 hex through 7e hex). 'Restore defaults' restores the password to "admin", but note that if power has been cycled since a successful login one cannot get to 'restore defaults' without knowing the password. ****Note: Power cycle is required when completed.**

The user password feature is available in firmware version 8.09 and subsequent.

For security reasons forgotten passwords can only be reset to factory defaults with the physical return of the switch to N-TRON or to an authorized N-TRON distributor.

```
CLI\SYSTEM>upwd
Enter User password (4 to 8 characters), or <(ESC)> *****
Confirm User password, or <(ESC)> *****

User password assigned.

CLI\SYSTEM>
```

Note that when a user password is defined, the password prompt will ask "Enter User Password" instead of "Enter Password":

```
Login - (Enter Username)> admin
Username is correct.

Login continued - (Enter User Password)>
```

Switch Menu

Command	Description
mirror	Enable, disable, and configure port mirroring
trunking	Enable, disable, and configure trunking
qos	Enable, disable, and configure port or tagged Quality of Service
vlan	Enable, disable, and configure Virtual Local Area Networks
igmp	Enable, disable, and configure IGMP Snooping
filters	Select traffic filter(s)
ports	Reconfigure Individual Port Parameters

Port Mirroring

Mirroring allows the data exchange at one port (mirrored port, or source port) to be mirrored to another port (monitor port, capture port, or destination port) where it can be recorded with a protocol analyzer, or other analysis can be performed.

Command	Description	Comment
info	Displays the current Mirroring settings.	
disable (or enable)	Enable or Disable Mirroring	Choice is opposite of current state
config	Configure Port Mirroring.	Select source and destination ports, and set to mirror TX, RX, or Both.

Notes on Port Mirroring:

- A single port must be assigned as the source port. Any port in the switch may be chosen.
- A single port must be assigned as the destination port.
The choice is limited based on the source port. Entries are ranged to prevent issues. The destination port must be in the same group as the source port, as below:
 - 1 through 8, and 25
 - 9 through 16
 - 17 through 24, and 26This information is presented to the user on the CLI, as needed.
- There is a choice to Mirror (I)ncoming, (O)utgoing, or <(B)oth>. 'Both' is the default on just <ENTER>.
- **N-View™** frames are not mirrored.

Note:

With port mirroring enabled, the 500 series switch will forward the traffic (ingress, egress, or both) from the source port to the destination port. Note that this results in mirrored packets being transmitted out the destination port even though the source and destination addresses of that packet are not associated with that port. This does not present a problem if the device attached to the mirror port is a PC.

However, if the mirror destination port is connected to another switch, that unit will learn and associate the source address in the packet with that port. As a result, that switching device will block either incoming or outgoing traffic (the opposite type of what was learned, as a protection mechanism to prevent loops). Therefore, to monitor a mirrored port, it is best to directly connect a PC or network analyzer (sniffer) to the mirror destination port, and not through a network.

Example of the Mirroring config screen:

```
CLI\SWITCH\MIRROR>config

Configure MIRROR Function

For Port Mirroring, the Source Port is now: 17
Select Source Port [1...26] :
Enter Port Number (or ESC to exit):5

For Port Mirroring, the Source Port is now: 5

For Port Mirroring, the Destination Port is now: 'out of range'

Select Destination Port, one of: 1 2 3 4 6 7 8 25

Enter Port Number (or ESC to exit):9

Select Destination Port, one of: 1 2 3 4 6 7 8 25

Enter Port Number (or ESC to exit):8

For Port Mirroring, the Destination Port is now: 8

Mirror (I)ncoming, (O)utgoing, or <(B)oth> i

Port Mirroring is DISABLED.
When enabled, all frames received at port5
will be mirrored to port8.

CLI\SWITCH\MIRROR>
```

Example of the Mirroring info screen:

```
CLI\SWITCH\MIRROR>info

Port Mirroring is DISABLED.
When enabled, all frames received at port5
will be mirrored to port8.

CLI\SWITCH\MIRROR>
```

MAC Based Trunking

MAC Based Trunking provides performance and provides media redundancy. See an example below for multiple 508/509 Trunking configuration.

Command	Description	Comment
info	Display the current Trunking settings.	
disable (or enable)	Enables or Disables Trunking	Choice is opposite of current state
config	Configure Trunking	Group1 and/or/nor 2

Notes on Trunking:

- Mirroring overrides trunking (does mirror on the other trunk line). Can be used together carefully.
- Functionality, **when trunking is enabled**, on the **500 series** is:
 - If Trunk Groups 1 & 2 are both Activated:
 - Ports 1 & 2 are a pair of forwarding ports.
 - Ports 7 & 8 are a pair of forwarding ports.
 - * Each pair dynamically balances traffic and dynamically fails over.
 - * If port 1 goes down, ports 1/2 traffic is remapped to port 2 only.
 - * If port 2 goes down, ports 1/2 traffic is remapped to port 1 only.
 - * If port 7 goes down, ports 7/8 traffic is remapped to port 8 only.
 - * If port 8 goes down, ports 7/8 traffic is remapped to port 7 only.
 - * If both trunk ports of a pair are available, trunking is restored to normal.
 - If Trunk Group1 is Activated and Trunk Group2 is Deactivated:
 - Ports 1 & 2 are a pair of forwarding ports.
 - * The pair dynamically balances traffic and dynamically fails over.
 - * If port 1 goes down, ports 1/2 traffic is remapped to port 2 only.
 - * If port 2 goes down, ports 1/2 traffic is remapped to port 1 only.
 - * If both trunk ports are available, trunking is restored to normal.
 - If Trunk Group1 is Deactivated and Trunk Group2 is Activated:
 - Ports 7 & 8 are a pair of forwarding ports (functioning as above).

Example Configuration for 508/509 Trunking:

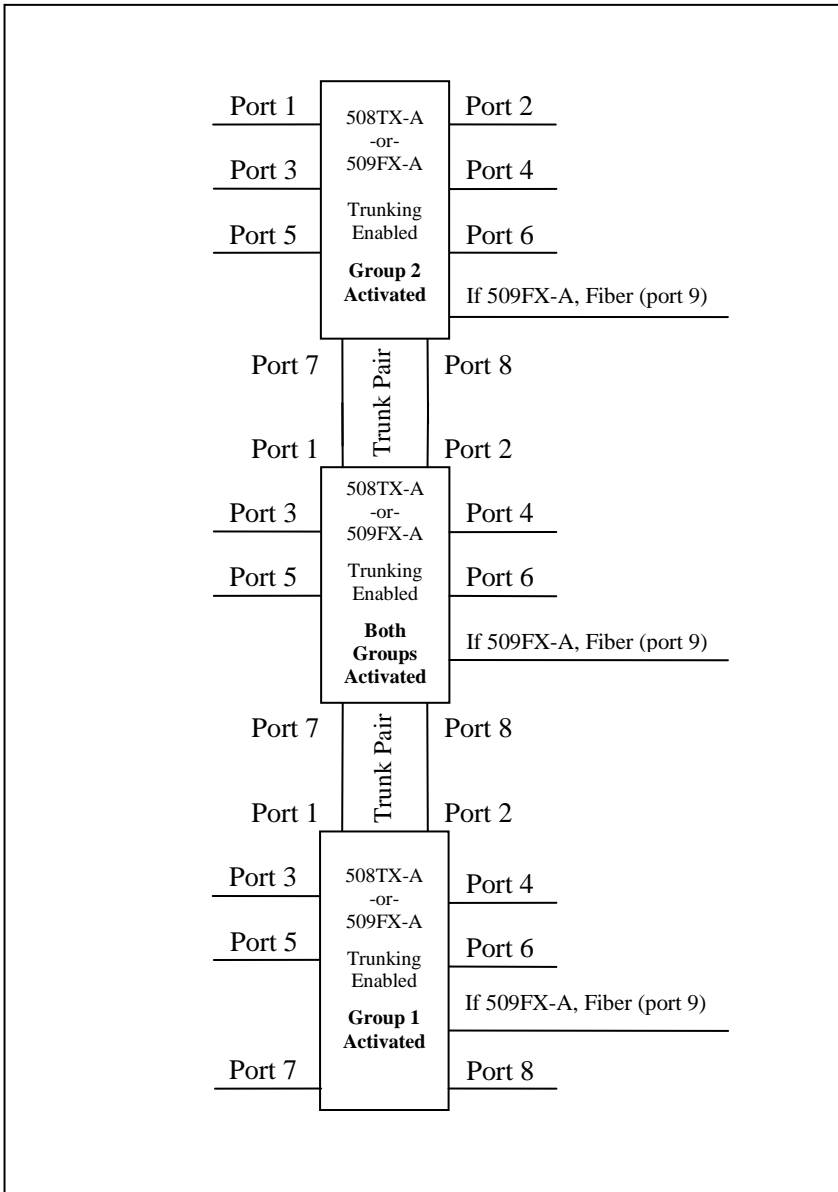

Example of the Trunking config screen:

```

CLI\SWITCH\TRUNK>config

Configure Trunking.

Trunking is ENABLED.

Trunk Group1 is now Active.

Trunk Group2 is now Inactive.

Enter: <(ESC)> to keep this configuration,
      'A' to Activate both groups,
      'D' to Deactivate both groups,
      '1' to activate Group1 and deactivate Group2, OR
      '2' to activate Group2 and deactivate Group1.
Enter A, D, 1, 2, or <(ESC)> A
Activated both groups.

CLI\SWITCH\TRUNK>

```

Example of the Trunking info screen:

```

CLI\SWITCH\TRUNKING>info

Trunking (Link Aggregation) is ENABLED.
Trunking (Link Aggregation) Groups 1 and 2 are both now Activated.
Ports 1 & 2 are a pair of forwarding ports.
Ports 7 & 8 are a pair of forwarding ports.

CLI\SWITCH\TRUNKING>

```

QOS

The –A units support tagged and/or port based QOS. When both tagged and port based qos are enabled, port based takes priority where there is conflict. The –N and basic (no dash) units have both QOS types disabled. The –A units have both QOS types disabled in default (for version 7.08 and later firmware).

Tagged (IEEE 802.1p) Quality of Service (QOS) provides traffic priority based upon values within the ethernet frames coming into the switch. There is a configurable QOS Priority Threshold (0 to 7). When an incoming 802.1p priority tag value is greater than or equal to this number, the incoming packet will be classified as high priority. The default QOS threshold is: 4. Note that the same ‘threshold’ is used for all ports and that ports are either ALL enabled or ALL disabled.

Port Based QOS is disabled by default and can be enabled with any number of ports selected. The selected ports then have higher priority than the unselected ports.

Command	Description	Comment
info	Displays the current QOS settings.	
dis_tag (or en_tag)	Enable or Disable Tagged QOS	Choice is opposite of current state
set_tag	Set Tagged QOS threshold - 802.1p	
dis_port (or en_port)	Enable or Disable Port QOS	Choice is opposite of current state
set_port	Set Port QOS - higher priority ports	

Example of the Tagged QOS config screen:

```
CLI\SWITCH\QOS>set_tag  
  
Configure Tagged QOS Threshold.  
  
The Tagged QOS threshold is now: 4  
  
When an incoming 802.1p priority tag value is greater than or  
equal to this number, the incoming packet will be classified as  
high priority.  
  
Please Select Tagged QOS Threshold [0-7]: 6  
  
The Tagged QOS threshold is now: 6  
  
CLI\SWITCH\QOS>
```

Example of the Port QOS config screen:

```
CLI\SWITCH\QOS>set_port  
  
Configure Port QOS. Select higher priority ports.  
  
These ports are higher priority for Port QOS: none  
  
Enter ports to enable>  
Use commas to separate port numbers.  
(Example: '3,6,12,14<enter>'.)  
Enter Port Numbers (or ESC to exit)> 1,5,8  
  
These ports are higher priority for Port QOS: 1 5 8  
  
CLI\SWITCH\QOS>
```

Example of the QOS info screen:

```
CLI\SWITCH\QOS>info  
  
Tagged (802.1P) QOS is ENABLED.  
The Tagged QOS threshold is: 6.  
  
Port QOS is ENABLED.  
These ports are higher priority for Port QOS: 1 5 8  
  
CLI\SWITCH\QOS>
```

VLAN

A local area network (LAN) is a private network usually confined to one plant. Virtual LANs (VLANs) allow a single physical LAN to be partitioned into several smaller logical LANs. VLANs are an effective means of portioning a larger LAN into manageable subsets. VLANs restrict the broadcast domain, improve performance and security, and they are ideal for isolating industrial automation systems from IT systems while retaining the plant's structural wiring.

The simplest of VLANs to implement are Port VLANs, but in some cases the most effective VLAN scheme is the IEEE 802.1Q VLAN tagging standard that improves mobility by allowing a user to potentially access any VLAN from any point on the LAN. More flexibility is gained if VLAN associations can be learned from the contents of the Ethernet frame.

Security and traffic reduction can be provided with Port VLAN or with Tagged VLAN in accordance with IEEE 802.1Q. VLAN is a function to divide a switch internally into virtual groups. As the switch is divided into several VLAN groups, the broadcast domain is divided also, thus restraining broadcast packets and enhancing security. Broadcast and multicast frames are constrained by VLAN boundaries so only stations whose ports are members of the same VLAN see those frames. Also, flooding of unlearned unicast frames goes only to VLAN members.

Tag-based VLAN uses an extra tag in the MAC header to identify the VLAN membership of a frame. The four-byte tag is inserted immediately after the source address and before the Type/Length field. The **VLAN ID (VID)** associates a frame with a specific VLAN and provides the information that switches need to process the frame across the network. A VID must be assigned for each VLAN. By assigning the same VID to VLANs on many switches, one or more VLANs can be extended across a large network.

Notice that there is no change in Ethernet frames (external to the switch) with **Port VLAN** partitioning. End stations are unaware of the VLAN structure.

Whether using Port or Tagged VLAN, clear one group by entering a zero as the VID, and clear all groups with a "cleargroups" command.

Each port has one and only one **PVID (Port VLAN Identifier)**. If using tagged vlan and incoming frames are tagged, the PVID will not come into play at all. If untagged incoming packets are accepted by a port, the port's PVID will be used as the tag for routing inside the switch. The PVID determines group membership of the packet, so where packets can go or not. If also the port transmits tagged for the group, that PVID (used for untagged incoming frame) will then be used outgoing.

If no port belongs to more than one group, the defaults (just enter) will take care of the PVIDs. Whether using PORT or TAGGED VLAN, if one is using shared VLAN (port(s) with more than one group membership), one must understand the use of PVIDs.

As a simple port vlan example, take:

VLAN GROUP2 includes these Ports: 1 2 3 4 5

VLAN GROUP3 includes these Ports: 4 5 6 7 8 9

VLAN GROUP4 includes these Ports: 1 2 3 4 5 6 7 8 9

Ports 1,2,3 each have a PVID of 2; Ports 4,5 each have a PVID of 4; Port 6,7,8,9 each have a PVID of 3.

An untagged frame coming in from a PC on port 4 gets a PVID of 4, so has a VLAN group of ports 1 2 3 4 5 6 7 8 9.

An untagged frame coming in from a control system device on port 1 has a PVID of 2, so has a VLAN group of ports 1 2 3 4 5.

An untagged frame coming in from an office device on port 6 has a PVID of 3, so has a VLAN group of ports 4 5 6 7 8 9.

Thus: ports 1,2,3 - control system (only communicate with each other and the 2 PC's)

ports 4,5 - PCs (each communicate with all ports 1 thru 9)

ports 6,7,8,9 office system (only communicate with each other and the 2 PC's) For example: TX 7 to 3 and no ports RX.

(Detailed setup of this configuration is presented later.)

Tagged VLAN

Tagged VLAN is in accordance with IEEE 802.1Q.

When configuring each group:

- choose VID (2-511 ranged on input) (except group1 is always VID=1)
- choose member ports (any, all or none)
- by port, choose if this is the primary VID for the port.
- by port, for this group, choose if outgoing packets are untagged (a port could tx untagged if one VID and tagged if another VID)

When configuring untagged incoming packet handling:

- Drop all untagged incoming packets, or which ports to do this on.
(If untagged incoming packets are accepted by a port, the port's PVID will be used as the tag.
If also the port transmits tagged for the group, that PVID will be used outgoing.)

Note that:

- 'bfilter' must be disabled (all ports receiving broadcast) before enabling vlan.
- Ports are deleted from group1 as each port is added to another group.
- Ports are added to group1 if a deletion leaves a port with no group.
(Every port always has at least one group.)
- These automatic adds/deletes to/from group1 are messaged to the console.
- If it is desired to have a port on group1 and also on other group(s) configure group1 last to achieve that.
If group1 is configured last and ports are left out of all groups, they'll be added to group1 and you'll see a message.

Warnings:

Network administrators must ensure ports with non-802.1Q-compliant devices attached are configured to transmit untagged frames. Many network interface cards for PCs and printers are not 802.1Q-compliant. If they receive a tagged frame, they will not understand the VLAN tag and will drop the frame. Also, the maximum legal Ethernet frame size for tagged frames was increased in 802.1Q (and its companion, 802.3ac) from 1,518 to 1,522 bytes. This could cause network interface cards and older switches to drop tagged frames as "oversized."

Up to 8 VLAN groups can be configured, and each group can have from zero to all ports as members.

Tagged VLAN Menu:

Command	Description	Comment
info	Displays the current VLAN settings.	
disable (or enable)	Enable or Disable VLAN	Choice is opposite of current state
untagged	Untagged pkt handling	How to handle untagged incoming packets, by port
port	Switch to Port Based VLAN	
group1	configure tagged VLAN Group 1	Select VID and member ports
group2	configure tagged VLAN Group 2	Select VID and member ports
group3	configure tagged VLAN Group 3	Select VID and member ports
group4	configure tagged VLAN Group 4	Select VID and member ports
Group5	configure tagged VLAN Group 5	Select VID and member ports
Group6	configure tagged VLAN Group 6	Select VID and member ports
Group7	configure tagged VLAN Group 7	Select VID and member ports
Group8	configure tagged VLAN Group 8	Select VID and member ports
cleargroups	clear all 8 tagged VLAN Groups	

When VLAN is enabled, all ports are members of VID 1 by default. If you enter 'group2', for example, you'll be asked to enter (in decimal) a VLAN ID (VID) in the range of 1 through 511. Then, you'll be asked to enter the ports that are to participate in that tagged VLAN. Then, you'll be asked if all these ports are to have that VID as their PVID or not. Then, you'll be asked if you want outgoing packets to be untagged for all these ports or not. The defaults used on pressing <enter> without a value are denoted by parentheses, as in "(YES)".

Example of the Tagged VLAN config (groupX) screen, taking default choices:

Note that for the defaults choices (just enter) all chosen ports have the group VID as their PVID, and outgoing packets are untagged for all group ports.

```
CLI\SWITCH\VLAN>group2

Configure Tagged VLAN Group 2.

Enter VID or <(ESC)> to exit> 215
Enter ports to Join VLAN Group 2
(Example: '3,6,12,14<enter>'.)
Enter Port Numbers (or ESC to exit)> 2,6,17

These ports were removed from group1: 2 6 17

Would you like all these ports to have PVID=215 ?
Enter 'NO' or (YES):
CLI>

For incoming pkts with tagged VID=215, the outgoing pkts are untagged
for ports: 2 6 17

Do you want to change this ?
Enter 'YES' or (NO):
CLI>

CLI\SWITCH\VLAN>
```

Example of the Tagged VLAN config (groupX) screen, not taking default choices:

This example below chooses only some (not all) group ports to have the group VID as their PVID, and outgoing packets to be untagged for some (not all) group ports.

```
CLI\SWITCH\VLAN>group7

Configure Tagged VLAN Group 7.

Enter VID or <(ESC)> to exit> 325
Enter ports to Join VLAN Group 7
(Example: '3,6,12,14<enter>'.)
Enter Port Numbers (or ESC to exit)> 1,2,3,4,5,6,17

These ports were removed from group1: 1 3 4 5

Would you like all these ports to have PVID=325 ?
Enter 'NO' or (YES):
CLI>no
Enter ports to have PVID=325
(Example: '3,6,12,14<enter>'.)
Enter Port Numbers (or ESC to exit)> 1,3,4,5

For incoming pkts with tagged VID=325, the outgoing pkts are untagged
for ports: 1 2 3 4 5 6 17

Do you want to change this ?
Enter 'YES' or (NO):
CLI>yes
For VID=325 enter ports for outgoing untagged pkts:
(Example: '3,6,12,14<enter>'.)
Enter Port Numbers (or ESC to exit)> 1,6,9

CLI\SWITCH\VLAN>
```

Example of changing the way that untagged incoming packets are handled:

```
CLI\SWITCH\VLAN>untagged

Tagged VLAN: Handling Untagged Incoming Pkts:
Untagged pkts to these ports are discarded: all
Would you like to change that ? Enter 'YES' or (NO):
CLI>yes
Enter Port Numbers for which to drop incoming untagged pkts
(or just <enter> for no ports)
(or ESC to exit)> 1,8

CLI\SWITCH\VLAN>
```

Example of tagged vlan info:

```
CLI\SWITCH\VLAN>info
```

Tagged VLAN is DISABLED.

When enabled:

Untagged pkts to these ports are discarded: 1 8

VLAN GROUP1 has VID= 1 and includes Ports: 7 8 9 10 11 12 13 14 15 16

GROUP1 outgoing pkts are untagged for ports: 7 8 9 10 11 12 13 14 15 16

VLAN GROUP2 has VID=215 and includes Ports: 2 6 17

GROUP2 outgoing pkts are untagged for ports: 2 6 17

VLAN GROUP7 has VID=325 and includes Ports: 1 2 3 4 5 6 17

GROUP7 outgoing pkts are untagged for ports: 1 6

There is more. Press 'SPACE BAR' to continue, or escape to exit.

For each port, except port(s): 1 8

untagged incoming pkts will use these PVIDs to determine group membership:

Port 1 PVID=325

Port 2 PVID=215

Port 3 PVID=325

Port 4 PVID=325

Port 5 PVID=325

Port 6 PVID=215

Port 7 PVID=1

Port 8 PVID=1

Port 9 PVID=1

Port 10 PVID=1

Port 11 PVID=1

Port 12 PVID=1

Port 13 PVID=1

Port 14 PVID=1

Port 15 PVID=1

Port 16 PVID=1

Port 17 PVID=215

```
CLI\SWITCH\VLAN>
```

Tagged VLAN Example scenario:

This example illustrates a case where all devices attached to the switch are VLAN unaware, except the 'feed' from another switch or router on port 1. All devices on this switch are in VLAN VID=4, which is unique in a topology that includes multiple switches.

- port 1 accepts and sends only tagged VID=4 frames.
(discards any other incoming - untagged or other tags not 4)
(sends no untagged nor any other tags not 4)
- the other ports (2 thru 17) send out only untagged frames.
they accept untagged frames.
they discard frames tagged other than VID=4.
they will accept tagged vid=4 frames (which wouldn't matter if those devices do not do tagged vlan)

```
CLI\SWITCH\VLAN>enable
Tagged VLAN is Enabled.
CLI\SWITCH\VLAN>group2
Configure Tagged VLAN Group 2.
Enter VID or <(ESC)> to exit> 4
Enter ports to Join VLAN Group 2
(Example: '3,6,12,14<enter>'.)
Enter Port Numbers (or ESC to exit)> 1,2,3,4,5,6,7,8,9,10,11,12,13,14,15,16,17
These ports were removed from group1: 1 2 3 4 5 6 7 8 9 10 11 12 13 14 15 16 17
Would you like all these ports to have PVID=4 ?
Enter 'NO' or (YES):
CLI>
For incoming pkts with tagged VID=4, the outgoing pkts are untagged
for ports: all
Do you want to change this ?
Enter 'YES' or (NO):
CLI>yes
For VID=4 enter ports for outgoing untagged pkts:
(Example: '3,6,12,14<enter>'.)
Enter Port Numbers (or ESC to exit)> 2,3,4,5,6,7,8,9,10,11,12,13,14,15,16,17
CLI\SWITCH\VLAN>untagged
Tagged VLAN: Handling Untagged Incoming Pkts:
Untagged pkts to these ports are discarded: all
Would you like to change that ? Enter 'YES' or (NO):
CLI>yes
Enter Port Numbers for which to drop incoming untagged pkts
(or just <enter> for no ports)
(or ESC to exit)> 1
CLI\SWITCH\VLAN>
```

Continued on next sheet....

Tagged VLAN Example scenario: (continued from previous sheet)

```
CLI\SWITCH\VLAN>info
```

Tagged VLAN is ENABLED.

Untagged pkts to these ports are discarded: 1

VLAN GROUP1 has VID= 1 and includes Ports: none

GROUP1 outgoing pkts are untagged for ports: none

VLAN GROUP2 has VID= 4 and includes Ports: all

GROUP2 outgoing pkts are untagged for ports: 2 3 4 5 6 7 8 9 10 11 12 13 14 15
16 17

There is more. Press 'SPACE BAR' to continue, or escape to exit.

For each port, except port(s): 1

untagged incoming pkts will use these PVIDs to determine group membership:

Port 1 PVID=4

Port 2 PVID=4

Port 3 PVID=4

Port 4 PVID=4

Port 5 PVID=4

Port 6 PVID=4

Port 7 PVID=4

Port 8 PVID=4

Port 9 PVID=4

Port 10 PVID=4

Port 11 PVID=4

Port 12 PVID=4

Port 13 PVID=4

Port 14 PVID=4

Port 15 PVID=4

Port 16 PVID=4

Port 17 PVID=4

```
CLI\SWITCH\VLAN>
```

Port VLAN

Port VLAN is accomplished entirely within the switch itself. All incoming frames can be untagged, or if tagged the tag will be replaced by the PVID (see explanation above). Incoming packets will use the (internal to the switch) PVIDs to determine group membership. All outgoing frames will be untagged. All unlearned packets will flood only to all group member ports. Multicast and Broadcast will go only to group members.

When configuring each group:

- choose member ports (any, all or none)
- by port, choose if this is the primary VID for the port.
(group1 always=PVID of 1, group 2 = PVID of 2,...)

Note that:

- 'bfilter' must be disabled (all ports receiving broadcast) before enabling vlan.
- Ports are deleted from group1 as each port is added to another group.
- Ports are added to group1 if a deletion leaves a port with no group.
(Every port always has at least one group.)
- These automatic adds/deletes to/from group1 are messaged to the console.
- If it is desired to have a port on group1 and also on other group(s) configure group1 last to achieve that.
If group1 is configured last and ports are left out of all groups, they'll be added to group1 and you'll see a message.

Port VLAN Menu:

Command	Description	Comment
info	Displays the current VLAN settings.	
disable (or enable)	Enable or Disable VLAN	Choice is opposite of current state
tagged	Switch to Tagged VLAN	
group1	configure tagged VLAN Group 1	Select VID and member ports
group2	configure tagged VLAN Group 2	Select VID and member ports
group3	configure tagged VLAN Group 3	Select VID and member ports
group4	configure tagged VLAN Group 4	Select VID and member ports
Group5	configure tagged VLAN Group 5	Select VID and member ports
Group6	configure tagged VLAN Group 6	Select VID and member ports
Group7	configure tagged VLAN Group 7	Select VID and member ports
Group8	configure tagged VLAN Group 8	Select VID and member ports
cleargroups	clear all 8 tagged VLAN Groups	

Example of the Port VLAN config (groupX) screen, taking default choice for PVID:

Note that for the defaults choices (just enter) all chosen ports have the group VID as their PVID, and outgoing packets are untagged for all group ports.

```
CLI\SWITCH\VLAN>group3
Configure Port VLAN Group 3.

Enter ports to Join VLAN Group 3
(Example: '3,6,12,14<enter>'.)
Enter Port Numbers (or ESC to exit)> 4,5,6,7,8,9

These ports were removed from group1: 6 7 8 9

Would you like all these ports to have PVID=3 ?
Enter 'NO' or (YES):
CLI>
CLI\SWITCH\VLAN>
```

Example of the Port VLAN config (groupX) screen, not taking default choice for PVID:

This example below chooses only some (not all) group ports to have the group VID as their PVID.

```
CLI\SWITCH\VLAN>group4

Configure Port VLAN Group 4.

Enter ports to Join VLAN Group 4
(Example: '3,6,12,14<enter>'.)
Enter Port Numbers (or ESC to exit)> 1,2,3,4,5,6,7,8,9

Would you like all these vlan ports to have PVID=4 ?
Enter 'NO' or (YES):
CLI>no
Enter ports to have PVID=4
(Example: '3,6,12,14<enter>'.)
Enter Port Numbers (or ESC to exit)> 4,5

CLI\SWITCH\VLAN>
```

Example of port vlan info:

```
CLI\SWITCH\VLAN>info

Port VLAN is ENABLED.
All outgoing frames will be untagged.

VLAN GROUP1 includes Ports: 10 11 12 13 14 15 16 17
VLAN GROUP2 includes Ports: 1 2 3 4 5
VLAN GROUP3 includes Ports: 4 5 6 7 8 9
VLAN GROUP4 includes Ports: 1 2 3 4 5 6 7 8 9
VLAN GROUP5 includes Ports: none
VLAN GROUP6 includes Ports: none
VLAN GROUP7 includes Ports: none
VLAN GROUP8 includes Ports: none

There is more. Press 'SPACE BAR' to continue, or escape to exit.

Incoming pkts will use these PVIDs to determine group membership:
Port 1 PVID=2
Port 2 PVID=2
Port 3 PVID=2
Port 4 PVID=4
Port 5 PVID=4
Port 6 PVID=3
Port 7 PVID=3
Port 8 PVID=3
Port 9 PVID=3
Port 10 PVID=1
Port 11 PVID=1
Port 12 PVID=1
Port 13 PVID=1
Port 14 PVID=1
Port 15 PVID=1
Port 16 PVID=1
Port 17 PVID=1

CLI\SWITCH\VLAN>
```

Port VLAN Example scenario :

ports 1,2,3 - control system (only communicate with each other and the 2 PC's)

ports 4,5 - PCs (each communicate with all ports 1 thru 9)

ports 6,7,8,9 office system (only communicate with each other and the 2 PC's)

For example: TX 7 to 3 and no ports RX.

Notice below,, the configuration step:

“Would you like all these ports to have PVID=4 ?

Enter 'NO' or (YES):

CLI>no

Enter ports to have PVID=4

(Example: '3,6,12,14<enter>'.)

Enter Port Numbers (or ESC to exit)> 4,5”

```
CLI\SWITCH\VLAN>port
```

Wait.....

Port VLAN selected.

```
CLI\SWITCH\VLAN>enable
```

Port VLAN is Enabled.

```
CLI\SWITCH\VLAN>group2
```

Configure Port VLAN Group 2.

Enter ports to Join VLAN Group 2

(Example: '3,6,12,14<enter>'.)

Enter Port Numbers (or ESC to exit)> 1,2,3,4,5

These ports were removed from group1: 1 2 3 4 5

Would you like all these ports to have PVID=2 ?

Enter 'NO' or (YES):

CLI>

```
CLI\SWITCH\VLAN>group3
```

Configure Port VLAN Group 3.

Enter ports to Join VLAN Group 3

(Example: '3,6,12,14<enter>'.)

Enter Port Numbers (or ESC to exit)> 4,5,6,7,8,9

These ports were removed from group1: 6 7 8 9

Would you like all these ports to have PVID=3 ?

Enter 'NO' or (YES):

CLI>

Continued on next sheet....

Port VLAN Example scenario: (continued from previous sheet)

```
CLI\SWITCH\VLAN>group4
```

Configure Port VLAN Group 4.

Enter ports to Join VLAN Group 4

(Example: '3,6,12,14<enter>'.)

Enter Port Numbers (or ESC to exit)> 1,2,3,4,5,6,7,8,9

Would you like all these ports to have PVID=4 ?

Enter 'NO' or (YES):

```
CLI>no
```

Enter ports to have PVID=4

(Example: '3,6,12,14<enter>'.)

Enter Port Numbers (or ESC to exit)> 4,5

```
CLI\SWITCH\VLAN>info
```

Port VLAN is ENABLED.

All outgoing frames will be untagged.

VLAN GROUP1 includes Ports: 10 11 12 13 14 15 16 17

VLAN GROUP2 includes Ports: 1 2 3 4 5

VLAN GROUP3 includes Ports: 4 5 6 7 8 9

VLAN GROUP4 includes Ports: 1 2 3 4 5 6 7 8 9

VLAN GROUP5 includes Ports: none

VLAN GROUP6 includes Ports: none

VLAN GROUP7 includes Ports: none

VLAN GROUP8 includes Ports: none

There is more. Press 'SPACE BAR' to continue, or escape to exit.

Incoming pkts will use these PVIDs to determine group membership:

Port 1 PVID=2

Port 2 PVID=2

Port 3 PVID=2

Port 4 PVID=4

Port 5 PVID=4

Port 6 PVID=3

Port 7 PVID=3

Port 8 PVID=3

Port 9 PVID=3

Port 10 PVID=1

Port 11 PVID=1

Port 12 PVID=1

Port 13 PVID=1

Port 14 PVID=1

Port 15 PVID=1

Port 16 PVID=1

Port 17 PVID=1

```
CLI\SWITCH\VLAN>
```

IGMP Snooping

In factory defaults, IGMP Snooping is enabled, and the switch is **Plug and Play** for IGMP. IGMP snooping provides intelligent network support for multicast applications. In particular, unneeded traffic is reduced. IGMP Snooping is configured via the console and if enabled, then operates dynamically upon each power up and until entering escape to the console terminates it. Also, there can be manual only or manual and dynamic operation (as described below). Note that “static filters” (‘sfilter’ below) can be used whether IGMP Snooping is enabled or not. At the end of this section, see “Example of an IGMP info screen “ for a summary example.

Command	Description	Comment
info	Displays the current IGMP settings.	
disable (or enable)	Enable or Disable IGMP	Choice is opposite of current state
routers	Manage Router Port(s) for IGMP Snooping	Router Ports can be manually set and/or auto-detected.
rfilters	Manage Router Multicast Data Filters	Router ports can get or not get the IGMP group data (as opposed to controls like joins, leaves, and queries).
query	Manage Query Generation	Query Generation can be manually set and/or automatically done.

Out of the box, IGMP Snooping will function dynamically without intervention. If some of the devices in the LAN do not understand IGMP, then manual settings are provided to accommodate them.

The Internet Group Management Protocol (IGMP) is a protocol that provides a way for a computer to report its multicast group membership to adjacent ‘routers’. In this case N-Tron 500 series –A switches provide **router-like functionality**. Multicasting allows one computer to send content to multiple other computers that have identified themselves as interested in receiving the originating computer's content. Multicasting can be used to transmit only to an audience that has joined (and not left) a multicast group membership. IGMP version 2 is formally described in the Internet Engineering Task Force (IETF) Request for Comments (RFC) 2236. IGMP version 1 is formally described in the Internet Engineering Task Force (IETF) Request for Comments (RFC) 1112. The 500 series supports v1 and v2.

Example of the IGMP router management screen:

```
CLI\SWITCH\IGMP>routers
```

```
For IGMP Snooping, router ports mode is auto.  
Manually Selected Router Port(s): none  
Automatically detected Router Port(s): none
```

```
Enter: <(ESC)> to keep this configuration, OR  
      'A' to Auto-detect plus manual, OR  
      'M' for Manual only, OR  
      'N' for None.
```

```
Enter A, M, N , (or ESC to exit) >
```

Example of entering manually selected routers in auto-detect plus manual:

(One does not have to manually enter anything for IGMP SNOOPING, unless accommodating non-IGMP devices.)

```
Enter A, M, N , (or ESC to exit) > a
```

```
For IGMP Snooping, router ports mode is auto.
```

```
Manually Selected Router Port(s): none
```

```
Automatically detected Router Port(s): none
```

```
Would you like to change that ? Enter 'YES' or (NO):
```

```
CLI> yes
```

```
Enter ports to be router ports:
```

```
Use commas to separate port numbers.
```

```
(Example: '3,6,12,14<enter>'.)
```

```
Enter Port Numbers (or ESC to exit)> 1,8,17
```

```
CLI\SWITCH\IGMP>
```

The 'rfilter' function allows you to choose whether or not DATA frames with KNOWN group multicast addresses are sent to the 'router' ports (links to other switches). Control packets (Join, Leave) will be sent to the router(s) regardless of this setting. "Known" can be known from dynamic IGMP Snooping operation and/or from setting of "static filters" (see below). **In firmware version 8.09 and subsequent the default is that the Router Multicast Data Filter is enabled for all ports, so any router ports do not get DATA frames with KNOWN multicast destination addresses unless a join to a specific multicast address has been received on that port. (Joins over-ride rfilter.) Rfilter can be set for individual ports: any, all, or none. For each port rfilter will have an impact only if that port is manually or dynamically chosen as a router port.**

Example of entering ports for rfilter to be applied:

(One does not have to manually enter anything, unless wanting to limit data to some 'router' (switch link) ports.)

```
CLI\SWITCH\IGMP>rfilters
```

```
Manage Router Multicast Data Filters for IGMP Snooping:
```

```
Rfilter is applied to these ports: none
```

```
Would you like to change that ? Enter 'YES' or (NO):
```

```
CLI> yes
```

```
Enter ports to have Router Multicast Data Filters for IGMP Snooping  
applied when they are router ports:
```

```
Use commas to separate port numbers.
```

```
(Example: '3,6,12,14<enter>'.)
```

```
Enter Port Numbers (or ESC to exit)> 3,7,9
```

```
Rfilter is applied to these ports: 3 7 9
```

```
CLI\SWITCH\IGMP>
```

(continued)

The query management function enables the switch to generate IGMP “Query” messages: never, always, or automatically.

Example of Configure Query Generation screen:

```
CLI\SWITCH\IGMP>query

Configure Query Generation.

Query mode is auto.
Query Frame Source IP: 192.168.69.102.

Enter: <(ESC)> to keep this configuration, OR
      'A' to Auto query, OR
      'O' for query On, OR
      'F' for query oFF.

Enter A, O, F , (or ESC to exit) >
```

Note that by RFC, there should be only one entity issuing IGMP queries in a LAN and in the event of conflict the one with the lowest IGMP Source IP Address should continue and the others should stop sending queries. The Query Frame carries the unique switch MAC address as the physical layer “Source Address”. A default “Source IP” Address for deeper within the Query frame is calculated from the lower bits of the unique MAC address of the switch itself. It is unlikely, but possible, that the calculated (default) “Source IP Address” is redundant to another in your topology and that this could create an issue in a device that is monitoring IGMP Queries AND mapping these Addresses to some other parameter. In case you need to change the “Source IP” for the Query frame, when you select Query On or Auto, you will be shown the calculated address and asked if you’d like to change it (yes or no). **In 500 series switches, the “IGMP Query Source IP Address” is only for IGMP purposes. It cannot be ‘pinged’, for example.**

Example of changing IGMP Query Source IP Address:

(N-Tron is not aware of anyone ever having to change this, but the ability is provided..)

```
CLI\SWITCH\IGMP>query

Configure Query Generation.

Query mode is auto.
Query Frame Source IP: 192.168.69.102.

Enter: <(ESC)> to keep this configuration, OR
      'A' to Auto query, OR
      'O' for query On, OR
      'F' for query oFF.

Enter A, O, F , (or ESC to exit) > a
Query mode is auto.
Query Frame Source IP: 192.168.69.102.

Would you like to change that ? Enter 'YES' or (NO):
CLI> yes
Enter a Source IP Address for IGMP Queries (or ESC to exit):191.23.12.15

Query mode is auto.
Query Frame Source IP: 191.23.12.15.

CLI\SWITCH\IGMP>
```

Example of an IGMP info screen

(without cycling power, <ESCAPE>, SWITCH, IGMP, INFO):

```
CLI\SWITCH\IGMP>info

IGMP Snooping is ENABLED. When power is cycled:

Query mode is auto.
Query Frame Source IP: 191.23.12.15.

Received Lower Query Frame Source IP: 10.10.10.5.

For IGMP Snooping, router ports mode is auto.
Manually Selected Router Port(s): 3 17
Automatically detected Router Port(s): 4 5
Rfilter is applied to these ports: 5 8 17

These ports receive General Broadcast now: 1
There is a total of 1 Static Filter Active.

There is more info. Press 'SPACE BAR' to continue, or escape to exit.

There are a total of 3 Multicast Groups Active.

Address                Member Port(s)
-----
224.129.1.10           1 6 7
01-00-5E-0A-0B-0C      2 7 19 22           (static filter 1)
226.129.1.11           2 3 4

CLI\SWITCH\IGMP>
```

In the example above:

- The lower source IP query that was received is identified.
- Ports 3 and 17 were manually chosen as router (switch link) ports.
(**One does not have to manually enter anything**, unless accommodating non-IGMP devices.)
- Ports 4 and 5 were automatically detected as router (switch link) ports.
- Rfilter was applied for ports 5, 8, and 17.
 - Ports 5 and 17 were receiving IGMP control, but not igmp group data.
 - Ports 3 and 4 were receiving IGMP control AND igmp group data.
 - 'rfilter' on for port 8 will have had no impact, as it was not a router port.
- (**One does not have to manually enter anything**, unless desiring to limit data to some router ports.)
- There was one manually entered 'static' multicast group active (described below - 'sfilter').
(**One does not have to manually enter anything**, unless accommodating non-IGMP devices, or 'filtering' for other reasons.)
- There were two dynamically formed (with 'joins') igmp groups active.

As an example, incoming data frames with a destination address of 01-00-5E-0A-0A-0B were sent to ports 1, 6, and 7 as group members and to ports 3 and 4 as 'router' ports without rfilter set. Any joins or leaves were being sent to ports 3, 4, 5, and 17 as 'router' (switch link) ports.

Filters

Note that these filters operate whether IGMP Snooping is enabled or not. These are egress filters.

'General Broadcast' frames have a Destination Address of all ones (FF FF FF FF FF FF). The default is that all ports receive General Broadcast. You can select which ports are to receive General Broadcast, but only if vlan is not enabled.

At least twelve (16 on 524/526) 'static filters' are provided. You can use any, all, or none. For each employed, you will enter an address and the ports that will receive frames with the destination address for that static filter.

Command	Description	Comment
info	Get info on Filters	
bfilter	Configure Broadcast Filter Ports	Select Ports
sfilter	Configure Static Multicast Filter	Select Addresses and Ports for each

After entering 'bfilter', you will be asked to
"Enter ports that are to receive General Broadcast frames:"

After entering 'sfilter', you will be asked to enter the
"static multicast filter number (1 ->16)" (for 524/526)
or "static multicast filter number (1 ->12)" (for other 500 series products)
and then to
"Enter 12 digit Address (Ex. '01005e0a0a0a<enter>'), or all zeroes to disable the group".
Lastly, you will be asked to
"Enter ports that are to receive on this multicast address".

Note that the main intent is relative to Multicast Addresses, but other frame Destination Addresses can technically be used.

Each static filter group can have any or all switch ports in the group. Entering all (12) zeroes as the group multicast address disables that group, but allows the other groups to function. Multicast Group Addresses must be in the range of 01 00 5e 00 00 00 through 01 00 5e 7F FF FF. These low order 23 bits of the Multicast Group Address are the IP host address. Elsewhere, this same IP Multicast Group Address Range is sometimes expressed as 224.0.0.0 through 239.255.255.255 (dotted quad), but cannot be directly entered into the switch in that notation.

Note that IGMP Snooping operates dynamically and with or without these static filter entries.

Note that vlan must be disabled before enabling any 'bfilter's.

Example of the Filters bfilter screen:

```
CLI\SWITCH\FILTERS>bfilter
Enter ports that are to receive General Broadcast frames >
Use commas to separate port numbers. (Example: '3,6,12,14,22<enter>'.)
Enter Port Numbers (or ESC to exit):1,5,9,12,18,24,26
These ports receive General Broadcast now: 1 5 9 12 18 24 26
CLI\SWITCH\FILTERS>
```

Example of the Filters sfilter screen:

```

CLI\SWITCH\FILTERS>sfilter
Enter 1, 2, 3, ... ,16, or <(ESC)> >

Enter: <(ESC)> to cancel change and keep current configuration, or
static multicast filter number (1 ->16).
CLI> 1
Enter 12 digit Address (Ex. '01005e0a0a0a<enter>'),
or all zeroes to disable the group.
or [ESC] to Exit
CLI> 01005e010100
Enter ports that are to receive on this multicast address:
Use commas to separate port numbers. (Example: '3,6,12,14,22<enter>'.)
Enter Port Numbers (or ESC to exit):3,8,18,24,25
There is a total of 1 Static Filter Active.

CLI\SWITCH\FILTERS>

```

Example of the Filters info screen:

```

CLI\SWITCH\FILTERS>info

These ports receive General Broadcast now: 1 5 9 12 18 24 26

There is a total of 1 Static Filter Active.

Static Address          Static Member Port(s)
-----
01-00-5E-01-01-00      3 8 18 24 25          (static filter 1)

CLI\SWITCH\FILTERS>

```

In the case above, ethernet frames coming into the switch at any port, with a destination address within the frame of 01-00-5E-01-01-00 will go out of switch ports 3, 8, 18, 24, and 25, and only to those ports (excluding the port received on). For example, an ethernet frame with that address could come into switch port 1 and it would go out of switch ports 3, 8, 18, 24, and 25 only.

Literally thousands of switches in one normal LAN can have N-View enabled without negative impact, but one use of **sfilter** is related to reducing N-View related traffic from portions of LANs that include extremely low bandwidth wireless links. The example above (with destination address 01-00-5E-01-01-00) would filter out N-View frames coming from other switches in the LAN. Using the configuration above, port 2 for example would not get N-View frames from other switches in the LAN, but would get the few N-View frames from the switch at hand. To stop those also, N-View can be disabled on the switch at hand.

How to acquire the IGMP snooping multicast group addresses for static entry:

(One does not have to manually enter anything for this purpose, unless accommodating non-IGMP devices.)

- (1) The entire 12 hexadecimal digits can be identified with a sniffer.
- Or,
- (2) The address can be calculated from a known class D address for the particular multicast session or application.

Calculating the IGMP snooping multicast group addresses:

First, the class D address must be known. While some of these class D addresses are well known (224.0.1.1 is used by NTP Network Time Protocol specified in RFC1119 for instance), the majority are defined when the application is activated. Often, the class D address is the originating host computer's IP address.

In most applications, the user has the option of choosing their multicast group address as a session is established. The complete process of establishing IP multicast sessions is fully documented in RFC 1112 "Host Extensions for IP Multicasting" and the IGMP Version 2 RFC 2236. .

For the purposes of this document, only the process used to map a selected IP multicast class D address to a specific MAC layer multicast destination address is significant.

Once an application determines the class D IP multicast address it will utilize, that address must be mapped into a MAC layer multicast for delivery across any LAN based system. This process is outlined as follows:

Step 1: Using the Class D address, identify the low order 23 bits of the class D address.

Step2: Map those 23 bits into the low order 23 bits of a MAC address with the fixed high order 25 bits of the IEEE multicast addressing space prefixed by 01:00:5E.

An example of this process is shown below. This example assumes that the application has selected the IP class D address 226.129.1.10 and demonstrates the mapping of the low order 23 bits of the class D IP address to the low order bits of the MAC layer destination.

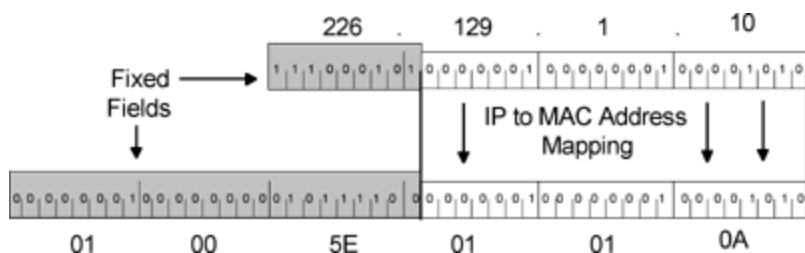

Mapping of class D 226.129.1.10 IP address to MAC layer multicast

The mapping of 226.129.1.10 to a MAC layer multicast was executed by placing the low order 23 bits of the class D address into the low order 23 bits of the reserved MAC layer multicast address 01:00:5E:xx:xx:xx. Since only 23 bits are mapped, the 24th significant bit is fixed at 0. The final MAC address that is utilized by the multicast group 226.129.1.10 is 01:00:5E:01:01:0A.

Ports

By default, the RJ45 ports are auto-sensing for speed, duplexing, and crossover or straight through wiring. When you select ANY 'forced' option, the auto-sensing for that port is disabled for all three parameters and the 'remaining' (unforced) options are set to 100 Mbits, Full Duplex, and straight through cabling. For example, if you select speed10 for port 2, then port 2 will be: speed10, full duplex, and straight through wiring. If you need 'half duplex' also on port 2, you will have to select it also as auto-sensing will be disabled for port 2 after you forced speed10. The FX ports are always 100 Mb, and Full Duplex.

Warning:

In a LAN it is best to set ALL devices at autonegotiate, OR to set ALL devices to the same mode (speed/duplex).

If one end of a link is set to forced speed/duplex, but the other end is not forced, problems can be created. Why do folks not trust autonegotiation? Many learned (mostly in past or on older equipment) not to trust autonegotiation. Why? Many implementations were out before the spec was finalized, so did not play well together. (We have seen a case where the wiring was cat3 and the devices autonegotiated to 100/full, but the wiring would not support it.)

On the 500 series, one can autonegotiate, or one can force to any of 4 modes: 100 full, 100 half, 10 full, or 10 half.

If you force one unit into 10/full, and leave another in autonegotiate (the default), the unit in autonegotiation does not go into 10 full. It goes into 10 half. It gets no autonegotiation response. It easily senses speed passively, but has no way to sense duplex mode and so uses the "safest" duplex mode - half. Per spec. Thus, you have one unit at 10 full and the other at 10 half - basically functional but not ideal. The unit at 10 full transmits without checking for busy and you get more collisions. Also, the 10/full unit does not back off or retransmit based on the collision domain.

Same happens with one unit forced to 100/full and the other autonegotiating. The autonegotiating unit goes into 100/half.

Command	Description	Next prompt:
info	Get info on Port Parameters	
enabling	Enable or disable each port	
negotiate	Select autonegotiate or not for each port	Enter ports that are to autonegotiate:
speed10	Force 10 Mb speed for each port	Enter forced 10 Mb ports:
speed100	Force 100 Mb speed for each port	Enter forced 100 Mb ports:
half	Force half duplex for each port	Enter forced Half Duplex ports:
full	Force full duplex for each port	Enter forced Full Duplex ports:
crossover	Force crossover connection for each port	Enter forced crossover ports:
link10h	Advertise 10Mb and half for each port	Enter ports to advertise 10Mb and half duplex:
filter	Configure Collision Filter for each port	First a chance to change the threshold for collision filter management, then entry of ports to be affected.
squelchon or squelchoff	Squelch more than IEEE standard (or not)	Choice is opposite of current state.

Each time you select a forced port function (speed, duplex, or crossover) the ports you enter next are the complete new set of ports for that function. For example, if you enter 'speed10', then respond with only <enter> (no ports) to the prompt "*Enter forced 10 Mb ports:*", then no ports in the switch will be forced to 10 Mb, regardless of prior history.

'Link10h' technically auto negotiates, but 'advertises' only 10 Mb and full duplex capability. 'Filter', by port, resets the port PHY if a (selectable) threshold number of collisions is exceeded in 20 seconds. These functions are off in default, but can be useful in high interference or with other problematic conditions.

Example of the Ports enabling screen:

```
CLI\SWITCH\PORTS>enabling

Enter ports to enable>
Use commas to separate port numbers. (Example: '3,6,12,14,22<enter>'.)
Enter Port Numbers (or ESC to exit):1,2,3,4,9,10,11,12,13

CLI\SWITCH\PORTS>
```

Example of the negotiate screen:

```
CLI\SWITCH\PORTS>negotiate

Enter ports that are to autonegotiate>
Use commas to separate port numbers.
(Example: '3,6,12,14<enter>'.)
Enter Port Numbers (or ESC to exit)> all

CLI\SWITCH\PORTS>
```

Example of the Ports speed10 screen:

```
CLI\SWITCH\PORTS>speed10

Enter forced 10 Mb ports>
Use commas to separate port numbers. (Example: '3,6,12,14,22<enter>'.)
Enter Port Numbers (or ESC to exit):5

CLI\SWITCH\PORTS>
```

Example of the Ports half (duplex) screen:

```
CLI\SWITCH\PORTS>half

Enter forced Half Duplex ports>
Use commas to separate port numbers. (Example: '3,6,12,14,22<enter>'.)
Enter Port Numbers (or ESC to exit):5

CLI\SWITCH\PORTS>
```

Example of the Ports crossover screen:

```
CLI\SWITCH\PORTS>crossover

Enter forced crossover ports>
Use commas to separate port numbers. (Example: '3,6,12,14,22<enter>'.)
Enter Port Numbers (or ESC to exit):2

CLI\SWITCH\PORTS>
```

Example of the Ports link10h screen:

(Revised 8/4/2009)

```
CLI\SWITCH\PORTS>link10h
```

Enter ports to advertise 10Mb and half duplex:
Use commas to separate port numbers. (Example: '3,6,12,14,22<enter>'.)
Enter Port Numbers (or ESC to exit):12,13

```
CLI\SWITCH\PORTS>
```

Example of the Ports filter screen:

```
CLI\SWITCH\PORTS>filter
```

The threshold for collision filter management is 10 collisions in 20 seconds.

Would you like to change it ? Enter 'YES' or (NO):
CLI>

Enter ports to apply collision filter to:
Use commas to separate port numbers. (Example: '3,6,12,14,22<enter>'.)
Enter Port Numbers (or ESC to exit):1,7,19

```
CLI\SWITCH\PORTS>
```

Example of the Ports info screen:

```
CLI\SWITCH\PORTS>info
```

These ports are Enabled: all
ALL RJ45 ports are now set to autonegotiate for speed and duplexing.
Ports 25 and 26 are set to 100 Mb and Full Duplex.
These ports advertise 10Mb and half duplex: none
At 10 collisions per 20 seconds, when power is cycled, these ports
are filtered: none
These ports are forced to 10 Mb speed:none
These ports are forced to 100 Mb speed: 25 26
These ports are forced to Half Duplex:none
These ports are forced to Full Duplex: 25 26
These ports are forced to Crossover:none
Squelch is now normal.

```
CLI\SWITCH\PORTS>
```

500 Series Stacked Switches IGMP Multicast Limitations

With Quality of Service (QOS) DISABLED, as in factory defaults out of box:

To prevent IGMP Multicast congestion problems, the following rules should be followed for multicast frames of up to 256 bytes each:

1. IGMP Snooping should be enabled, as in factory defaults out of box, and other multicasting devices in the LAN should be compliant.
2. No more than three stages of switches should be stacked if the bottom layer is composed of simultaneously multicasting devices. (Reference the figure below.)
3. In stage 1, all ports of any 500 series '-A' switch may be connected to multicasting devices.
NOTE: A fiber ring, backbone, or trunked architecture is basically stage 1 for these purposes.
4. In stage 2:
 - a. 508/509: No limit to uplinks from stage 1.
 - b. 516/517/524/526:
 - i. no limit to the number of 508/509's uplinking from stage 1.
 - ii. Limit = 15 of 516/517's uplinking from stage 1.
 - iii. Limit = 10 of 524/526's uplinking from stage 1.

NOTE: Simultaneous wire-speed unicast traffic has virtually no effect on these limits.

5. Stage 3 should have no more than 200 multicasting nodes below it.

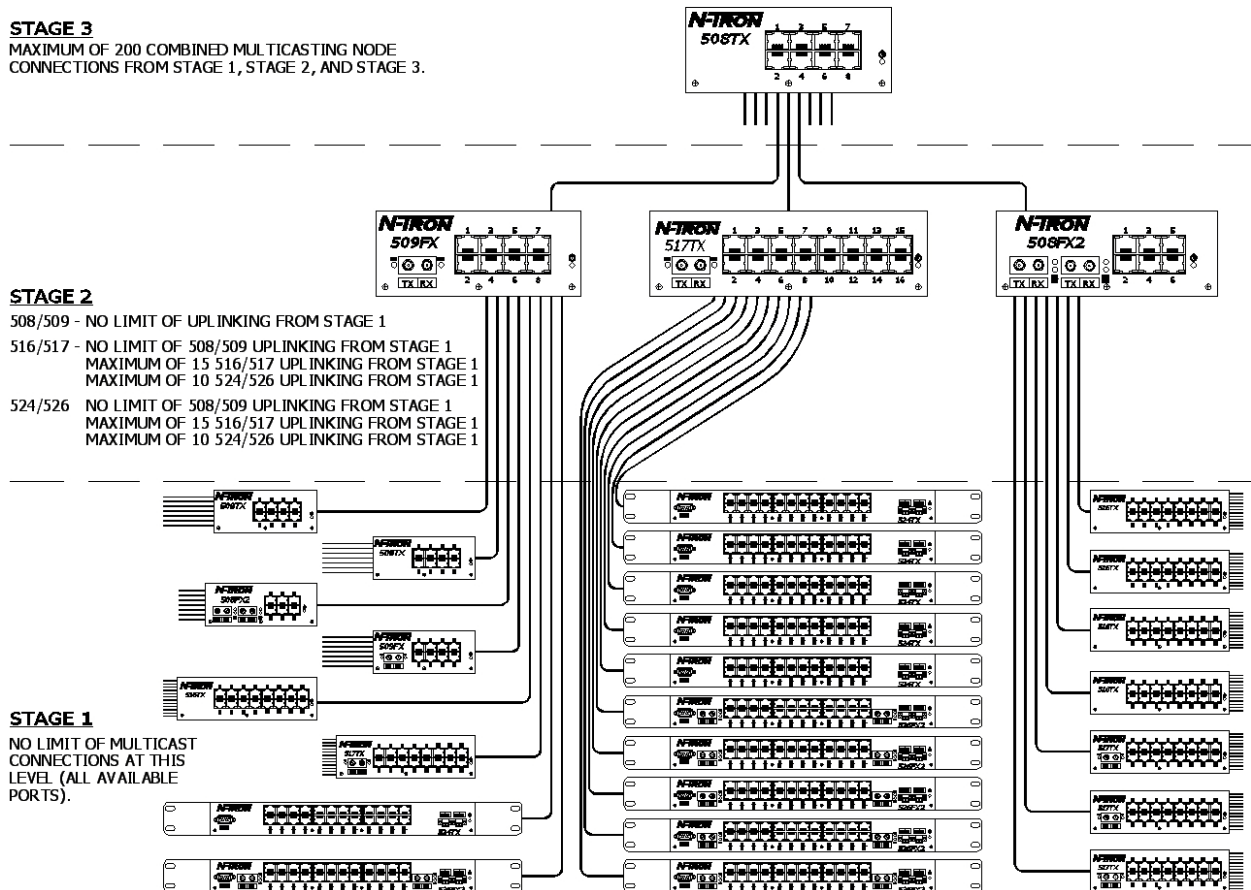

With Quality of Service (QOS) ENABLED, which would have to be manually configured:

To prevent IGMP Multicast congestion problems, the following rules should be followed for multicast frames of up to 256 bytes each, when QOS is enabled:

1. IGMP Snooping should be enabled, as in factory defaults out of box, and other multicasting devices in the LAN should be compliant.
2. No more than three stages of switches should be stacked if the bottom layer is composed of simultaneously multicasting devices. (Reference the figure below.)
3. In stage 1, all ports of any 500 series 'A' switch may be connected to multicasting devices.

NOTE: A fiber ring, backbone, or trunked architecture is basically stage 1 for these purposes.
4. In stage 2:
 - a. 508/509:
 - i. no limit to the number of 508/509's uplinking from stage 1.
 - ii. Limit = 6 of 516/517's uplinking from stage 1.
 - iii. Limit = 4 of 524/526's uplinking from stage 1.
 - b. 516/517/524/526:
 - i. Limit = 12 of 508/509's uplinking from stage 1.
 - ii. Limit = 6 of 516/517's uplinking from stage 1.
 - iii. Limit = 4 of 524/526's uplinking from stage 1.

NOTE: Simultaneous wire-speed unicast traffic has virtually no effect on these limits.

5. Stage 3 should have no more than 90 multicasting nodes below it.

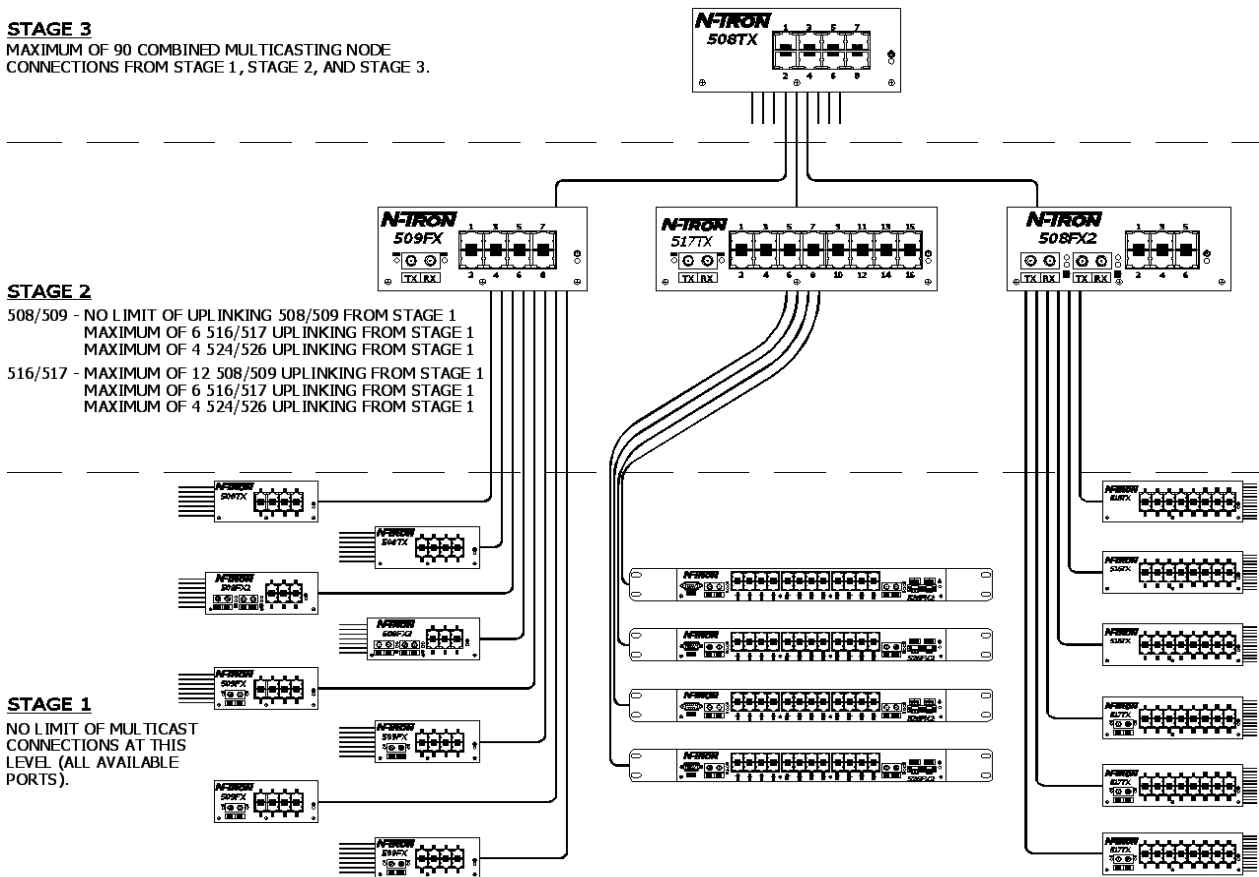

Key Specifications (508TX)

Switch Properties

Number of MAC Addresses	4,000
Aging Time	Programmable
Latency Min.	2.2 μ s
Backplane Speed	2.6Gb/s
Switching Method	Store & Forward

Physical

Height:	2.3"
Width:	5.5"
Depth:	3.5"
Weight:	1.6 lbs
Din-Rail:	35mm

Electrical

Redundant Input Voltage:	10-30 VDC
Input Current:	200 mA @ 24VDC (max current 0.5 A)
Inrush Current:	9.0 Amp/0.6 ms @ 24VDC
Input Ripple:	Less than 100 mV

Environmental

Operating Temp:	-40°C to 85°C
Storage Temp:	-40°C to 85°C
Operating Humidity:	10% to 95% (Non Condensing)
Operating Altitude:	0 to 10,000 ft.

Shock and Vibration

Shock:	200g @ 10ms
Vibration/Seismic:	50g, 5-200Hz, Triaxial

Note: Unit must be Bulkhead mounting to achieve these levels.

Reliability

MTBF:	>2Million Hours
-------	-----------------

Network Media

10BaseT:	>Cat3 Cable
100BaseTX:	>Cat5 Cable

Connectors

10/100BaseT:	Eight (8) RJ-45 Copper Ports
--------------	------------------------------

Serial Port

Com Parameters	9600,n,8,1
----------------	------------

Recommended Wiring Clearance:

Front:	2" (5.08 cm)
Side:	3" (7.62 cm)



Regulatory Approvals:

Safety: UL 1604 (US and Canada) Hazardous Locations, Class I, Div 2, Groups A, B, C, D, T4A
ATEX Zone 2, Category 3G, II 3G Ex nA IIC (DEMKO 03 ATEX 0316686U)
IEC61010-1/EN61010-1

EMI: EN61000-6-4, EN55011 – Class A
FCC 47 CFR, Part 15, Subpart B -Class A

EMS: EN61000-6-2
EN61000-4-2 (ESD)
EN61000-4-3 (RS)
EN61000-4-4 (EFT)
EN61000-4-5 (Surge)
EN61000-4-6 (Conducted Disturbances)

Conducted Low Frequency: IEC60533

Shock: IEEE 1613 (250 mm)
Vibration: IEEE 1613 (V.S.4 150 mm/s)
IEC60068-2-6 (Test Fc)
Cold: IEC60068-2-1
Dry Heat: IEC60068-2-2
Damp Heat: IEC60068-2-30 (Test Db)

GOST-R Certified.

Warranty: Effective January 1, 2008, all N-TRON products carry a 3 year limited warranty from the date of purchase.

Key Specifications (508FX2/FXE2)

Switch Properties

Number of MAC Addresses	4,000
Aging Time	Programmable
Latency Min.	2.2 μ s
Backplane Speed	2.6Gb/s
Switching Method	Store & Forward

Physical

Height:	2.3"
Width:	5.9"
Depth:	3.5"
Weight:	1.7 lbs
Din-Rail:	35mm

Electrical

Redundant Input Voltage:	10-30 VDC
Input Current:	380 mA @ 24VDC (max current 1.0 A)
Inrush Current :	8.5 Amp / 0.2 ms @ 24VDC
Input Ripple:	Less than 100 mV

Environmental

Operating and Storage Temp:	-40°C to 85°C
for -S option 508FX2:	-20°C to 70°C, Operating, -40°C to 85°C Storage
Operating Humidity:	10% to 95% (Non Condensing)
Operating Altitude:	0 to 10,000 ft.

Shock and Vibration

Shock:	200g @ 10ms
Vibration/Seismic:	50g, 5-200Hz, Triaxial
Note:	Unit must be Bulkhead mounting to achieve these levels.

Reliability

MTBF:	>2Million Hours
-------	-----------------

Network Media

10BaseT:	>Cat3 Cable
100BaseTX:	>Cat5 Cable
100BaseFX	
Multimode:	50-62.5/125 μ m
Singlemode:	7-10/125 μ m

Connectors

10/100BaseT:	Six (6) RJ-45 Copper Ports
100BaseFX:	Two (2) SC or ST Duplex Port

Serial Port

Com Parameters:	9600,n,8,1
-----------------	------------

Fiber Transceiver Characteristics

Fiber Length:	2km*	15km**	40km**	80km**
TX Power Min/Max	-19dBm/-14dBm	-15dBm/-7dBm	-5dBm/0dBm	-5dBm/0dBm
RX Sensitivity Max:	-32dBm	-34dBm	-34dBm	-34dBm
Wavelength:	1310nm	1310nm	1310nm	1550nm

*=Multimode ** =Singlemode

Recommended Wiring Clearance:

Front: 5" (12.7 cm)

Side: 3" (7.62 cm)

Regulatory Approvals:

Safety: UL 1604 (US and Canada) Hazardous Locations, Class I, Div 2, Groups A, B, C, D, T4A
ATEX Zone 2, Category 3G, II 3G Ex nA IIC (DEMKO 03 ATEX 0316686U)

EMI: EN61000-6-4, EN55011 – Class A
FCC 47 CFR, Part 15, Subpart B -Class A

EMS: EN61000-6-2
EN61000-4-2 (ESD)
EN61000-4-3 (RS)
EN61000-4-4 (EFT)
EN61000-4-5 (Surge)
EN61000-4-6 (Conducted Disturbances)

Conducted Low Frequency: IEC60533

Shock: IEEE 1613 (250 mm)

Vibration: IEEE 1613 (V.S.4 150 mm/s)
IEC60068-2-6 (Test Fc)

Cold: IEC60068-2-1

Dry Heat: IEC60068-2-2

Damp Heat: IEC60068-2-30 (Test Db)

GOST-R Certified.

Warranty: Effective January 1, 2008, all N-TRON products carry a 3 year limited warranty from the date of purchase.

Key Specifications (509FX/FXE)

Switch Properties

Number of MAC Addresses	4,000
Aging Time	Programmable
Latency Min.	2.2 μ s
Backplane Speed	2.6Gb/s
Switching Method	Store & Forward

Physical

Height:	2.3"
Width:	5.5"
Depth:	3.5"
Weight:	1.6 lbs
Din-Rail:	35mm

Electrical

Redundant Input Voltage:	10-30 VDC
Input Current:	260 mA @ 24VDC (max current 0.5 A)
Inrush Current:	8.5 Amp / 0.7 ms @ 24 VDC
Input Ripple:	Less than 100 mV

Environmental

Operating and Storage Temp:	-40°C to 85°C
for -S option 509FX:	-20°C to 70°C, Operating, -40°C to 85°C Storage
Operating Humidity:	10% to 95% (Non Condensing)
Operating Altitude:	0 to 10,000 ft.

Shock and Vibration

Shock:	200g @ 10ms
Vibration/Seismic:	50g, 5-200Hz, Triaxial
Note:	Unit must be Bulkhead mounting to achieve these levels.

Reliability

MTBF:	>2Million Hours
-------	-----------------

Network Media

10BaseT:	>Cat3 Cable
100BaseTX:	>Cat5 Cable
100BaseFX	
Multimode:	50-62.5/125 μ m
Singlemode:	7-10/125 μ m

Connectors

10/100BaseT:	Eight (8) RJ-45 Copper Ports
100BaseFX:	One (1) SC or ST Duplex Port

Serial Port

Com Parameters:	9600,n,8,1
-----------------	------------

Fiber Transceiver Characteristics

Fiber Length:	2km*	15km**	40km**	80km**
TX Power Min/Max	-19dBm/-14dBm	-15dBm/-7dBm	-5dBm/0dBm	-5dBm/0dBm
RX Sensitivity Max:	-32dBm	-34dBm	-34dBm	-34dBm
Wavelength:	1310nm	1310nm	1310nm	1550nm

*=Multimode **=Singlemode



Recommended Wiring Clearance:

Front: 5" (12.7 cm)

Side: 3" (7.62 cm)

Regulatory Approvals:

Safety: UL 1604 (US and Canada) Hazardous Locations, Class I, Div 2, Groups A, B, C, D, T4A
ATEX Zone 2, Category 3G, II 3G Ex nA IIC (DEMKO 03 ATEX 0316686U)
IEC61010-1/EN61010-1

EMI: EN61000-6-4, EN55011 – Class A
FCC 47 CFR, Part 15, Subpart B -Class A

EMS: EN61000-6-2
EN61000-4-2 (ESD)
EN61000-4-3 (RS)
EN61000-4-4 (EFT)
EN61000-4-5 (Surge)
EN61000-4-6 (Conducted Disturbances)

Conducted Low Frequency: IEC60533

Shock: IEEE 1613 (250 mm)

Vibration: IEEE 1613 (V.S.4 150 mm/s)
IEC60068-2-6 (Test Fc)

Cold: IEC60068-2-1

Dry Heat: IEC60068-2-2

Damp Heat: IEC60068-2-30 (Test Db)

GOST-R Certified.

Warranty: Effective January 1, 2008, all N-TRON products carry a 3 year limited warranty from the date of purchase.

Key Specifications (516TX)

Switch Properties

Number of MAC Addresses	4,000
Aging Time	Programmable
Latency Min.	2.2 μ s
Backplane Speed	2.6Gb/s
Switching Method	Store & Forward

Physical

Height:	2.3"
Width:	7.4"
Depth:	3.5"
Weight:	1.9 lbs
Din-Rail:	35mm

Electrical

Redundant Input Voltage:	10-30 VDC
Input Current:	400 mA @ 24VDC (max current 1.0 A)
Inrush Current:	7.0 Amp / 0.8 ms @ 24VDC
Input Ripple:	Less than 100 mV

Environmental

Operating Temp:	-40°C to 85°C
Storage Temp:	-40°C to 85°C
Operating Humidity:	10% to 95% (Non Condensing)
Operating Altitude:	0 to 10,000 ft.

Shock and Vibration

Shock:	200g @ 10ms
Vibration/Seismic:	50g, 5-200Hz, Triaxial
Note:	Unit must be Bulkhead mounting to achieve these levels.

Reliability

MTBF:	>2 Million Hours
-------	------------------

Network Media

10BaseT:	>Cat3 Cable
100BaseTX:	>Cat5 Cable

Connectors

10/100BaseT:	Sixteen (16) RJ-45 Copper Ports
--------------	---------------------------------

Serial Port

Com Parameters	9600,n,8,1
----------------	------------

Recommended Wiring Clearance:

Front:	2" (5.08 cm)
Side:	3" (7.62 cm)



Regulatory Approvals:

Safety: UL 1604 (US and Canada) Hazardous Locations, Class I, Div 2, Groups A, B, C, D, T4A
ATEX Zone 2, Category 3G, II 3G Ex nA IIC (DEMKO 03 ATEX 0316686U)
IEC61010-1/EN61010-1

EMI: EN61000-6-4, EN55011 – Class A
FCC 47 CFR, Part 15, Subpart B -Class A

EMS: EN61000-6-2
EN61000-4-2 (ESD)
EN61000-4-3 (RS)
EN61000-4-4 (EFT)
EN61000-4-5 (Surge)
EN61000-4-6 (Conducted Disturbances)

Conducted Low Frequency: IEC60533

Shock: IEEE 1613 (250 mm)
Vibration: IEEE 1613 (V.S.4 150 mm/s)
IEC60068-2-6 (Test Fc)
Cold: IEC60068-2-1
Dry Heat: IEC60068-2-2
Damp Heat: IEC60068-2-30 (Test Db)

GOST-R Certified.

Warranty: Effective January 1, 2008, all N-TRON products carry a 3 year limited warranty from the date of purchase.

Key Specifications (517FX/FXE)

Switch Properties

Number of MAC Addresses	4,000
Aging Time	Programmable
Latency Min.	2.2 μ s
Backplane Speed	2.6Gb/s
Switching Method	Store & Forward

Physical

Height:	2.3"
Width:	7.4"
Depth:	3.5"
Weight:	1.9 lbs
Din-Rail:	35mm

Electrical

Redundant Input Voltage:	10-30 VDC
Input Current:	440 mA @ 24VDC (max current 1.0 A)
Inrush Current:	8.5 Amp / 0.8 ms @ 24VDC
Input Ripple:	Less than 100 mV

Environmental

Operating and Storage Temp:	-40°C to 85°C
for -S option 517FX:	-20°C to 70°C, Operating, -40°C to 85°C Storage
Operating Humidity:	10% to 95% (Non Condensing)
Operating Altitude:	0 to 10,000 ft.

Shock and Vibration

Shock:	200g @ 10ms
Vibration/Seismic:	50g, 5-200Hz, Triaxial

Reliability

MTBF:	>2Million Hours
-------	-----------------

Network Media

10BaseT:	>Cat3 Cable
100BaseTX:	>Cat5 Cable
100BaseFX	
Multimode:	50-62.5/125 μ m
Singlemode:	7-10/125 μ m

Connectors

10/100BaseT:	Sixteen (16) RJ-45 Copper Ports
100BaseFX:	One (1) SC or ST Duplex Fiber Port

Serial Port

Com Parameters:	9600,n,8,1
-----------------	------------

Fiber Transceiver Characteristics

Fiber Length:	2km*	15km**	40km**	80km**
TX Power Min/Max	-19dBm/-14dBm	-15dBm/-7dBm	-5dBm/0dBm	-5dBm/0dBm
RX Sensitivity Max:	-32dBm	-34dBm	-34dBm	-34dBm
Wavelength:	1310nm	1310nm	1310nm	1550nm

*=Multimode **=Singlemode

(Revised 8/4/2009)



Recommended Wiring Clearance:

Front: 5" (12.7 cm)

Side: 3" (7.62 cm)

Regulatory Approvals:

Safety: UL 1604 (US and Canada) Hazardous Locations, Class I, Div 2, Groups A, B, C, D, T4A
ATEX Zone 2, Category 3G, II 3G Ex nA IIC (DEMKO 03 ATEX 0316686U)
IEC61010-1/EN61010-1

EMI: EN61000-6-4, EN55011 – Class A
FCC 47 CFR, Part 15, Subpart B -Class A

EMS: EN61000-6-2
EN61000-4-2 (ESD)
EN61000-4-3 (RS)
EN61000-4-4 (EFT)
EN61000-4-5 (Surge)
EN61000-4-6 (Conducted Disturbances)

Conducted Low Frequency: IEC60533

Shock: IEEE 1613 (250 mm)

Vibration: IEEE 1613 (V.S.4 150 mm/s)
IEC60068-2-6 (Test Fc)

Cold: IEC60068-2-1

Dry Heat: IEC60068-2-2

Damp Heat: IEC60068-2-30 (Test Db)

GOST-R Certified.

Warranty: Effective January 1, 2008, all N-TRON products carry a 3 year limited warranty from the date of purchase.

Key Specifications (524TX)

Switch Properties

Number of MAC Addresses	4,000
Aging Time	Programmable
Latency Min.	2.2 μ s
Backplane Speed	2.6Gb/s
Switching Method	Store & Forward



Physical

Height:	1.8"
Width:	19"
Depth:	4.3"
Weight:	3.7 lbs

Electrical

Redundant Input Voltage:	10-30 VDC
Input Current:	720 mA @ 24VDC (max current 1.0 A)
Inrush Current:	9.5 Amp / 0.75 ms @ 24VDC
Input Ripple:	Less than 100 mV

Environmental

Operating & Storage Temp:	-40°C to 85°C
Operating Humidity:	10% to 95% (Non Condensing)
Operating Altitude:	0 to 10,000 ft.

Shock and Vibration

Shock:	200g @ 10ms
Vibration/Seismic:	50g, 5-200Hz, Triaxial

Reliability

MTBF:	>1 Million Hours
-------	------------------

Network Media

10BaseT:	>Cat3 Cable
100BaseTX:	>Cat5 Cable

Connectors

10/100BaseT:	Twenty Four (24) RJ-45 Copper Ports
--------------	-------------------------------------

Serial Port

Com Parameters	9600,n,8,1
----------------	------------

Recommended Wiring Clearance:

Front:	2" (5.08 cm)
--------	--------------

Regulatory Approvals:

Safety: UL 1604 (US and Canada) Hazardous Locations, Class I, Div 2, Groups A, B, C, D, T4A
ATEX Zone 2, Category 3G, II 3G Ex nA IIC (DEMKO 03 ATEX 0316686U)

EMI: EN61000-6-4, EN55011 – Class A
FCC 47 CFR, Part 15, Subpart B -Class A

EMS: EN61000-6-2
EN61000-4-2 (ESD)
EN61000-4-3 (RS)
EN61000-4-4 (EFT)
EN61000-4-5 (Surge)
EN61000-4-6 (Conducted Disturbances)

Conducted Low Frequency: IEC60533

Shock: IEEE 1613 (250 mm)
Vibration: IEEE 1613 (V.S.4 150 mm/s)
IEC60068-2-6 (Test Fc)
Cold: IEC60068-2-1
Dry Heat: IEC60068-2-2
Damp Heat: IEC60068-2-30 (Test Db)

GOST-R Certified.

Warranty: Effective January 1, 2008, all N-TRON products carry a 3 year limited warranty from the date of purchase.

Key Specifications (526FX2/FXE2)

Switch Properties

Number of MAC Addresses	4,000
Aging Time	Programmable
Latency Min.	2.2 μ s
Backplane Speed	2.6Gb/s
Switching Method	Store & Forward



Physical

Height:	1.8"
Width:	19"
Depth:	4.3"
Weight:	3.7 lbs

Electrical

Redundant Input Voltage:	10-30 VDC
Input Current:	720 mA @ 24VDC (max current 1.0 A)
Inrush Current:	13.1 Amp / 0.93 ms @ 24VDC
Input Ripple:	Less than 100 mV

Environmental

Operating and Storage Temp:	-40°C to 85°C
for -S option 526FX2:	-20°C to 70°C, Operating, -40°C to 85°C Storage
Operating Humidity:	10% to 95% (Non Condensing)
Operating Altitude:	0 to 10,000 ft.

Shock and Vibration

Shock:	200g @ 10ms
Vibration/Seismic:	50g, 5-200Hz, Triaxial

Reliability

MTBF:	>1Million Hours
-------	-----------------

Network Media

10BaseT:	>Cat3 Cable
100BaseTX:	>Cat5 Cable
100BaseFX	
Multimode:	50-62.5/125 μ m
Singlemode:	7-10/125 μ m

Connectors

10/100BaseT:	Twenty Four (24) RJ-45 Copper Ports
100BaseFX:	Two (2) SC or ST Duplex Fiber Port

Serial Port

Com Parameters:	9600,n,8,1
-----------------	------------

Fiber Transceiver Characteristics

Fiber Length:	2km*	15km**	40km**	80km**
TX Power Min/Max	-19dBm/-14dBm	-15dBm/-7dBm	-5dBm/0dBm	-5dBm/0dBm
RX Sensitivity Max:	-32dBm	-34dBm	-34dBm	-34dBm
Wavelength:	1310nm	1310nm	1310nm	1550nm

*=Multimode **=Singlemode

(Revised 8/4/2009)

Recommended Wiring Clearance:

Front: 2" (5.08 cm)

Regulatory Approvals:

Safety: Listed as UL 1604 (US and Canada) Hazardous Locations, Class I, Div 2, Groups A, B, C, D, T4A
ATEX Zone 2, Category 3G, II 3G Ex nA IIC (DEMKO 03 ATEX 0316686U)

EMI: EN61000-6-4, EN55011 – Class A
FCC Title 47, Part 15, Subpart B - Class A

EMS: EN61000-6-2
EN61000-4-2 (ESD)
EN61000-4-3 (RS)
EN61000-4-4 (EFT)
EN61000-4-5 (Surge)
EN61000-4-6 (Conducted Disturbances)

Conducted Low Frequency: IEC60533

Shock: IEEE 1613 (250 mm)
Vibration: IEEE 1613 (V.S.4 150 mm/s)
IEC60068-2-6 (Test Fc)
Cold: IEC60068-2-1
Dry Heat: IEC60068-2-2
Damp Heat: IEC60068-2-30 (Test Db)

GOST-R Certified.

Warranty: Effective January 1, 2008, all N-TRON products carry a 3 year limited warranty from the date of purchase.

N-TRON Limited Warranty

N-TRON, Corp. warrants to the end user that this hardware product will be free from defects in workmanship and materials, under normal use and service, for the applicable warranty period from the date of purchase from N-TRON or its authorized reseller. If a product does not operate as warranted during the applicable warranty period, N-TRON shall, at its option and expense, repair the defective product or part, deliver to customer an equivalent product or part to replace the defective item, or refund to customer the purchase price paid for the defective product. All products that are replaced will become the property of N-TRON. Replacement products may be new or reconditioned. Any replaced or repaired product or part has a ninety (90) day warranty or the remainder of the initial warranty period, whichever is longer. N-TRON shall not be responsible for any custom software or firmware, configuration information, or memory data of customer contained in, stored on, or integrated with any products returned to N-TRON pursuant to any warranty.

OBTAINING WARRANTY SERVICE: Customer must contact N-TRON within the applicable warranty period to obtain warranty service authorization. Dated proof of purchase from N-TRON or its authorized reseller may be required. Products returned to N-TRON must be pre-authorized by N-TRON with a Return Material Authorization (RMA) number marked on the outside of the package, and sent prepaid and packaged appropriately for safe shipment. Responsibility for loss or damage does not transfer to N-TRON until the returned item is received by N-TRON. The repaired or replaced item will be shipped to the customer, at N-TRON's expense, not later than thirty (30) days after N-TRON receives the product. N-TRON shall not be responsible for any software, firmware, information, or memory data of customer contained in, stored on, or integrated with any products returned to N-TRON for repair, whether under warranty or not.

ADVANCE REPLACEMENT OPTION: Upon registration, this product qualifies for advance replacement. A replacement product will be shipped within three (3) days after verification by N-TRON that the product is considered defective. The shipment of advance replacement products is subject to local legal requirements and may not be available in all locations. When an advance replacement is provided and customer fails to return the original product to N-TRON within fifteen (15) days after shipment of the replacement, N-TRON will charge customer for the replacement product, at list price.

WARRANTIES EXCLUSIVE: IF AN N-TRON PRODUCT DOES NOT OPERATE AS WARRANTED ABOVE, CUSTOMER'S SOLE REMEDY FOR BREACH OF THAT WARRANTY SHALL BE REPAIR, REPLACEMENT, OR REFUND OF THE PURCHASE PRICE PAID, AT N-TRON'S OPTION. TO THE FULL EXTENT ALLOWED BY LAW, THE FOREGOING WARRANTIES AND REMEDIES ARE EXCLUSIVE AND ARE IN LIEU OF ALL OTHER WARRANTIES, TERMS, OR CONDITIONS, EXPRESS OR IMPLIED, EITHER IN FACT OR BY OPERATION OF LAW, STATUTORY OR OTHERWISE, INCLUDING WARRANTIES, TERMS, OR CONDITIONS OF MERCHANTABILITY, FITNESS FOR A PARTICULAR PURPOSE, SATISFACTORY QUALITY, CORRESPONDENCE WITH DESCRIPTION, AND NON-INFRINGEMENT, ALL OF WHICH ARE EXPRESSLY DISCLAIMED. N-TRON NEITHER ASSUMES NOR AUTHORIZES ANY OTHER PERSON TO ASSUME FOR IT ANY OTHER LIABILITY IN CONNECTION WITH THE SALE, INSTALLATION, MAINTENANCE OR USE OF ITS PRODUCTS. N-TRON SHALL NOT BE LIABLE UNDER THIS WARRANTY IF ITS TESTING AND EXAMINATION DISCLOSE THAT THE ALLEGED DEFECT OR MALFUNCTION IN THE PRODUCT DOES NOT EXIST OR WAS CAUSED BY CUSTOMER'S OR ANY THIRD PERSON'S MISUSE, NEGLIGENCE, IMPROPER INSTALLATION OR TESTING, UNAUTHORIZED ATTEMPTS TO OPEN, REPAIR OR MODIFY THE PRODUCT, OR ANY OTHER CAUSE BEYOND THE RANGE OF THE INTENDED USE, OR BY ACCIDENT, FIRE, LIGHTNING, POWER CUTS OR OUTAGES, OTHER HAZARDS, OR ACTS OF GOD.

LIMITATION OF LIABILITY: TO THE FULL EXTENT ALLOWED BY LAW, N-TRON ALSO EXCLUDES FOR ITSELF AND ITS SUPPLIERS ANY LIABILITY, WHETHER BASED IN CONTRACT OR TORT (INCLUDING NEGLIGENCE), FOR INCIDENTAL, CONSEQUENTIAL, INDIRECT, SPECIAL, OR PUNITIVE DAMAGES OF ANY KIND, OR FOR LOSS OF REVENUE OR PROFITS, LOSS OF BUSINESS, LOSS OF INFORMATION OR DATA, OR OTHER FINANCIAL LOSS ARISING OUT OF OR IN CONNECTION WITH THE SALE, INSTALLATION, MAINTENANCE, USE, PERFORMANCE, FAILURE, OR INTERRUPTION OF ITS PRODUCTS, EVEN IF N-TRON OR ITS AUTHORIZED RESELLER HAS BEEN ADVISED OF THE POSSIBILITY OF SUCH DAMAGES, AND LIMITS ITS LIABILITY TO REPAIR, REPLACEMENT, OR REFUND OF THE PURCHASE PRICE PAID, AT N-TRON'S OPTION. THIS DISCLAIMER OF LIABILITY FOR DAMAGES WILL NOT BE AFFECTED IF ANY REMEDY PROVIDED HEREIN SHALL FAIL OF ITS ESSENTIAL PURPOSE.

DISCLAIMER: Some countries, states, or provinces do not allow the exclusion or limitation of implied warranties or the limitation of incidental or consequential damages for certain products supplied to consumers, or the limitation of liability for personal injury, so the above limitations and exclusions may be limited in their application to you. When the implied warranties are not allowed to be excluded in their entirety, they will be limited to the duration of the applicable written warranty. This warranty gives you specific legal rights which may vary depending on local law.

GOVERNING LAW: This Limited Warranty shall be governed by the laws of the State of Alabama, U.S.A.